

User Manual

APPC-13XP



Content

- Declaration..... 3
- Product Instruction..... 3
- Power on the Product..... 4
- Insert SD Card 4
- Insert USB Devices..... 5
- Home Screen..... 6
- System Bar 9
- Applications 12
- Language..... 13
- Date & Time..... 14
- Volume 15
- Brightness 15
- Scheduled 15
- Wi-Fi..... 18
- Ethernet 19
- Bluetooth 20
- Virtual Keyboard..... 23
- Switch Input Methods..... 23
- Take Photos & Shots 24
- Surf Online 27
- Browse Files 27
- Play Media..... 29
- Install & Uninstall Apps..... 29
- Reset to Factory Default 34

Declaration

- ✓ Please read the instructions carefully before equipment installation and using the device.
- ✓ Do not put the product in high temperature, humid or dusty environment.
- ✓ Do not drop, crash or break down this product.
- ✓ This product is without battery, and after setting up any Settings on the Settings, it is recommended that the user should not immediately shutdown and confirm. Please wait for at least 5s before shutting down. For the system to save Settings data to database.
- ✓ Do not power off the device when it's formatting or upgrading, otherwise it will cause operation system error.
- ✓ This product is not waterproof.
- ✓ Use only approved add-on enhancements.

Product Instruction

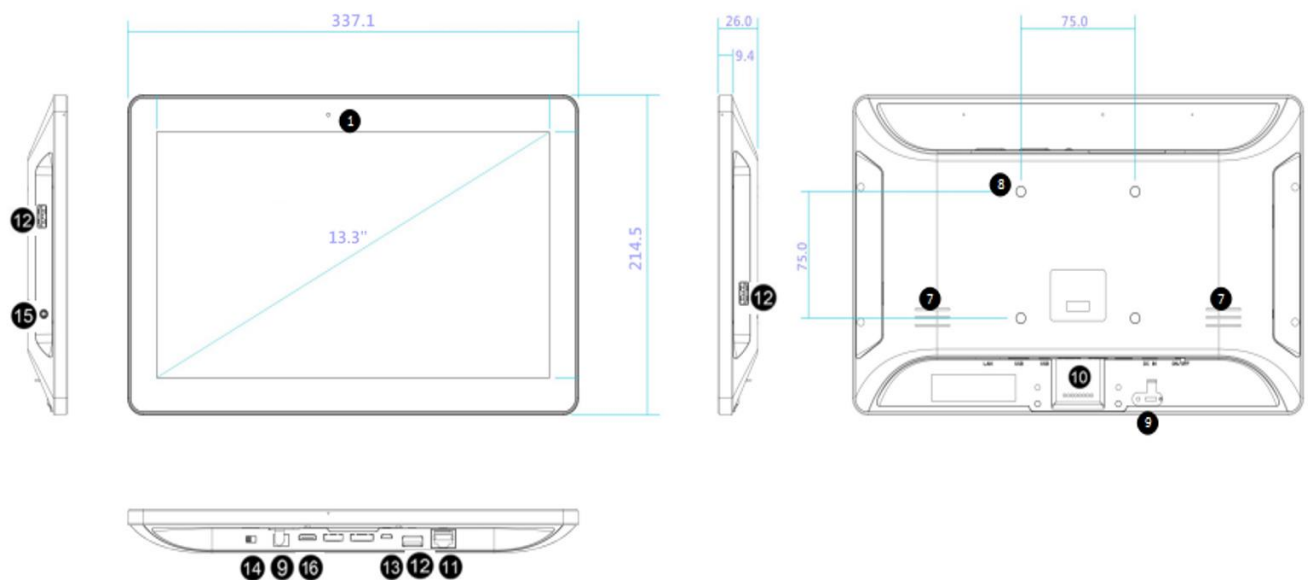

1. Camera (optional): 2M pixels camera

2. LED Indicator:

| | |
|------------------|----------------------|
| Green | Power supply is on. |
| Light Off | Power supply is off. |

3. SD Card Slot / Cover: support external SD card

4. Exit Button: return to the previous page

5. Function Keys (Up / Down): select the up/down item

6. Function Keys (Vol+ / Vol-): adjust the system volume

7. Speakers: audio output

- 8. VESA Mount Holes:** for installing the bracket
- 9. DC In Jack:** powered by 12V/2A DC adapter
- 10. Add-on module slot:** to put optional add-on module
- 11. 10/100/1000Mbps RJ45 Ethernet Port:** support Ethernet connection
- 12. USB Port:** support USB 2.0 Host type A
- 13. Micro-USB Port:** support Micro-USB 2.0
- 14. Power Switch:** switch power ON/OFF
- 15. Headphone audio port**
- 16. HDMI Port:** HDMI Type C output (covered, for production test only)
- 17. WIFI:** 802.11b/g/n/ac 2.4G
- 18. Temperature:** Operation: 0°C ~ 40°C (32F ~104F)
Storage: -10°C ~ 55°C (14°F ~ 131°F)

Power on the Product

Without Mounting Bracket

Step1 Power on the power adapter that connected to this product.

Step2 Switch the power switch (#14 in [Product Instruction](#)) next to DC in jack to **ON**.

Use Mounting Bracket

Step1 Put the mounting bracket to the back of the tablet, and tighten the installation screws on the screw holes.

Step2 Plug the power adapter into the DC in jack (#9 in [Product Instruction](#)) at the bottom of the mounting bracket, and then turn on the power switch (#14) at the bottom of the product.

Note: The mounting bracket contains battery inside. The power adapter can be unplugged once finishing charging. Please fully charge the battery before the first use.

Insert SD Card

This product supports external SD card. Please insert your SD card into the SD Card Slot (#3 in [Product Instruction](#)) on the top of this product.

Insert USB Devices

This product supports USB and Micro-USB to deal with your files.

USB

Plug your USB memory into the USB port (#12 in [Product Instruction](#)) on the bottom of this product, and then you can do the file operations via the File Browser. (See in [Browse Files](#)).

Micro-USB

Connect the Micro-USB port (#13 in [Product Instruction](#)) on the bottom of this product and the USB port on your computer with a Micro-USB-to-USB cable.

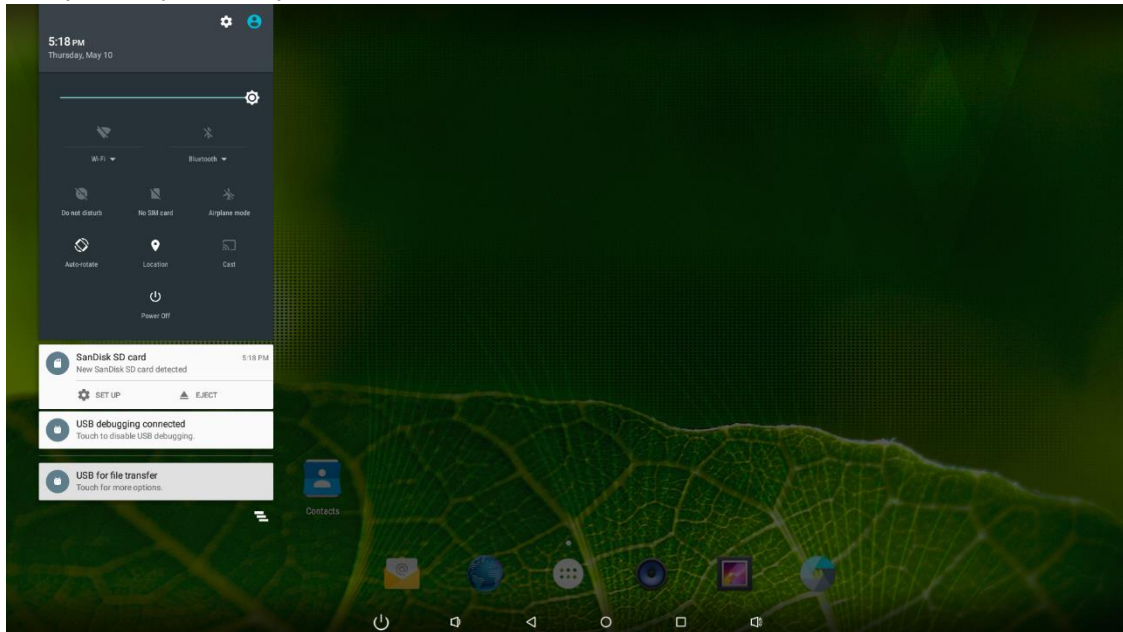

Click the “USB debugging connected” Entry “Developer options” interface;

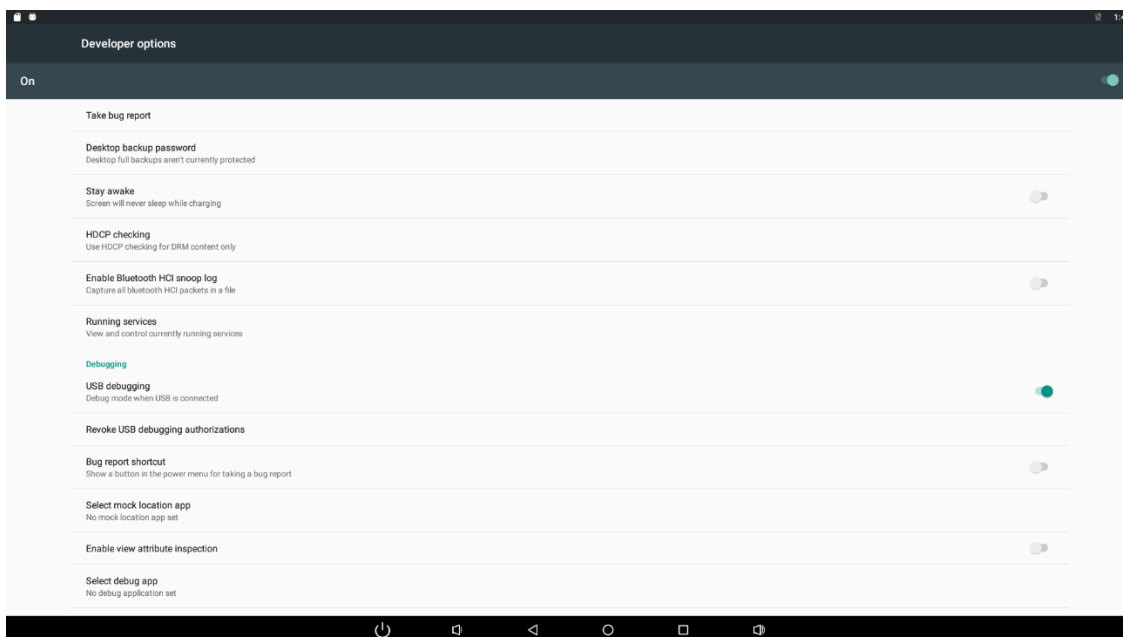

Click the “USB for file transfer” access to the USB use options interface.

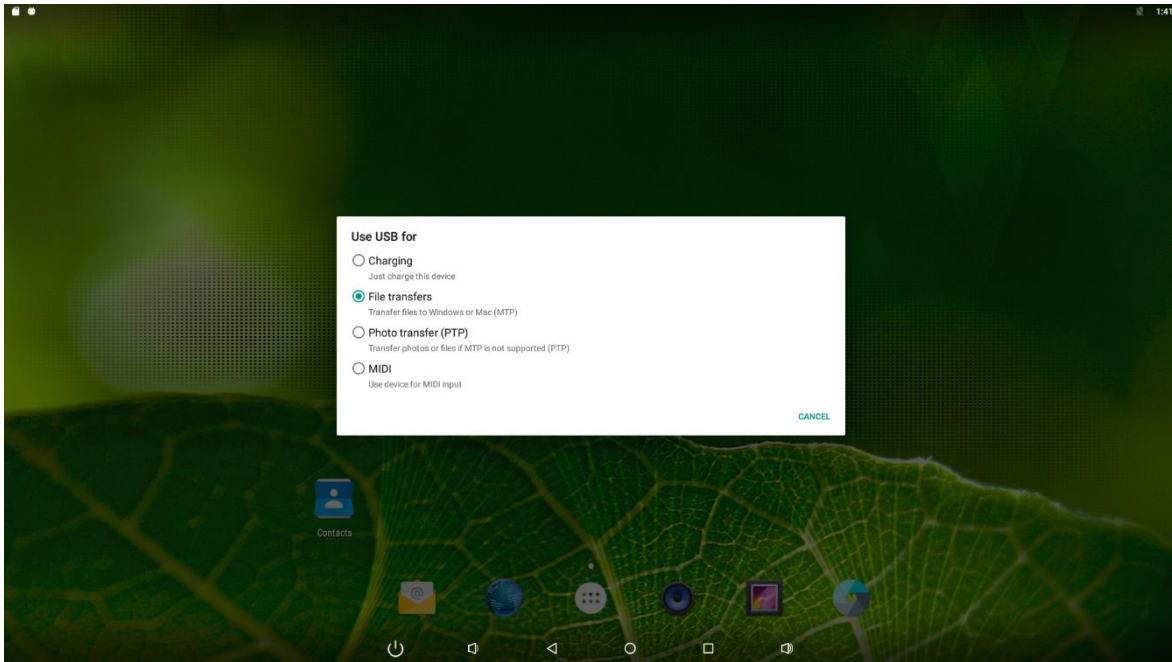

Home Screen

In the home screen, you can long-press the blank space to change the wallpaper or drag widgets to desktop.

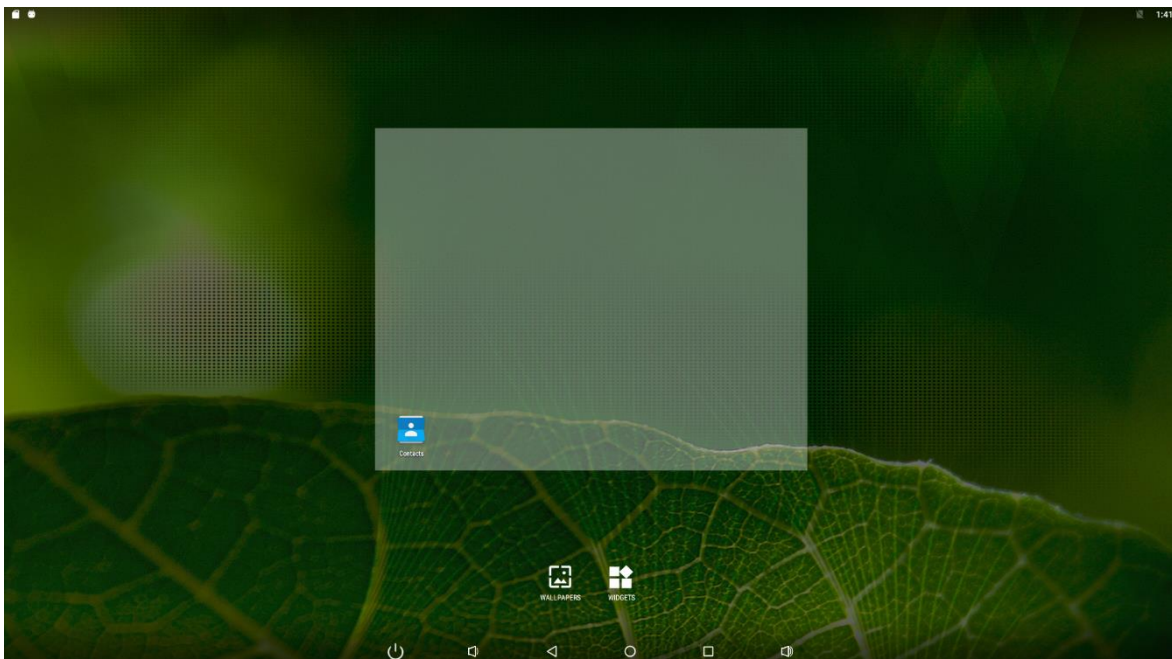

Change Wallpaper:

1. Click “WALLPAPER”.

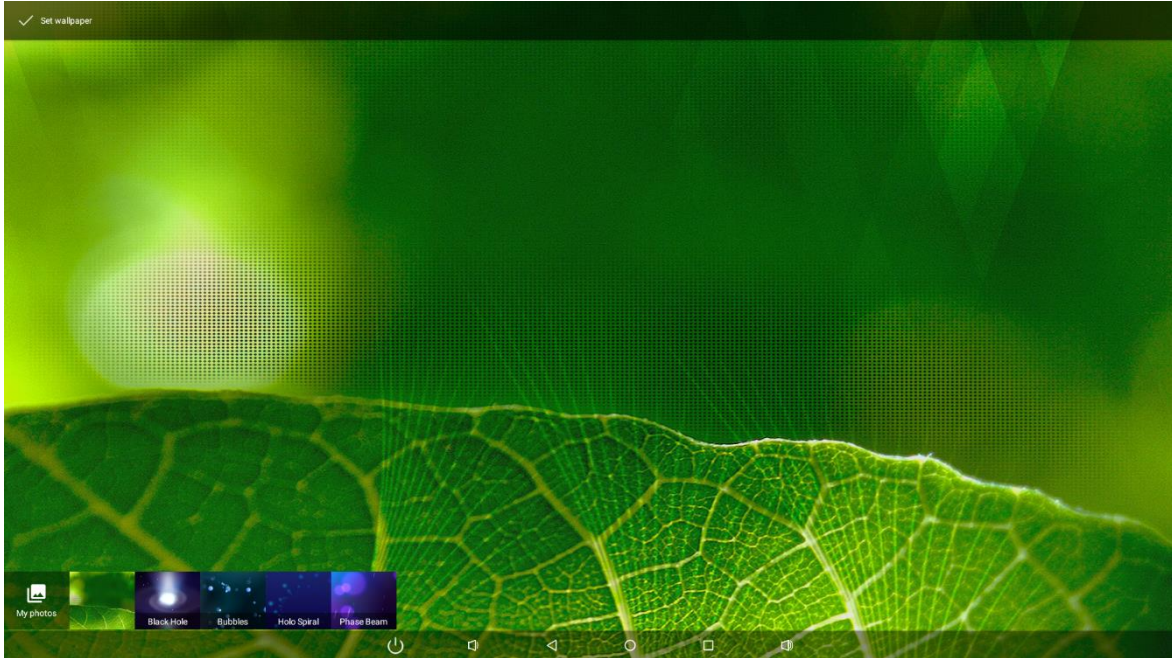

2. Select one picture from system presets or your own pictures.

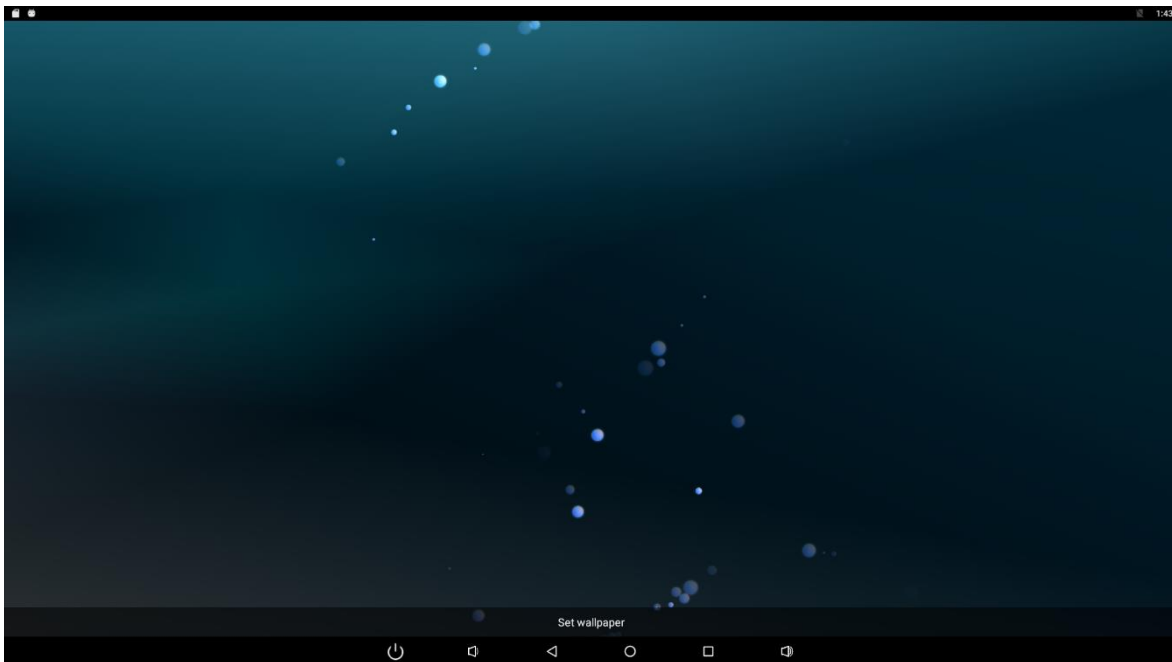

3. Click “Set wallpaper” on the middle corner of the screen to apply the wallpaper.

Add Widgets:

1. Click "WIDGETS".

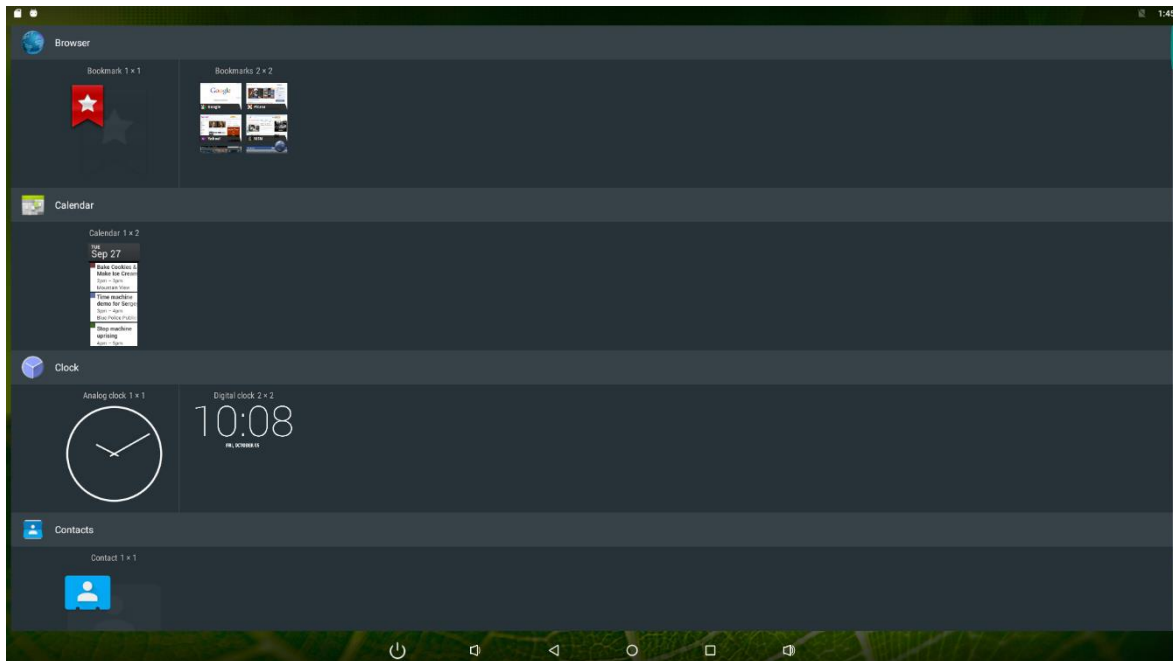

2. Long-press a widget and drag it to desktop.

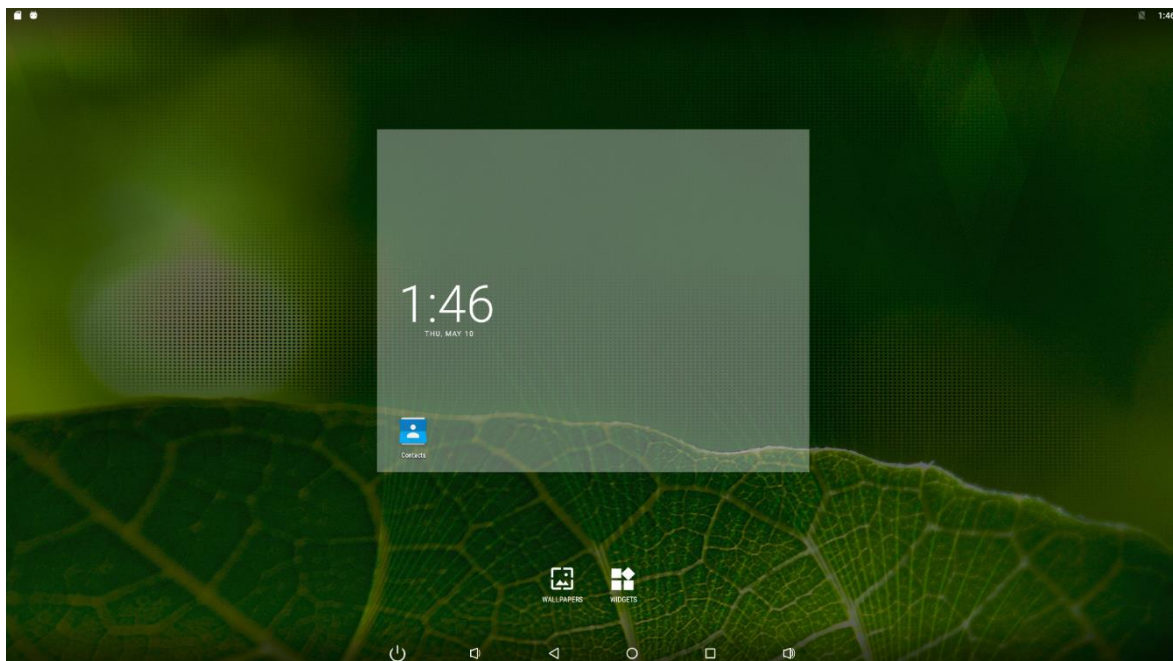

3. If you want to remove an icon, long-press the widget and drag it onto “×Remove” at the top of the screen and drop it until it turns light gray.

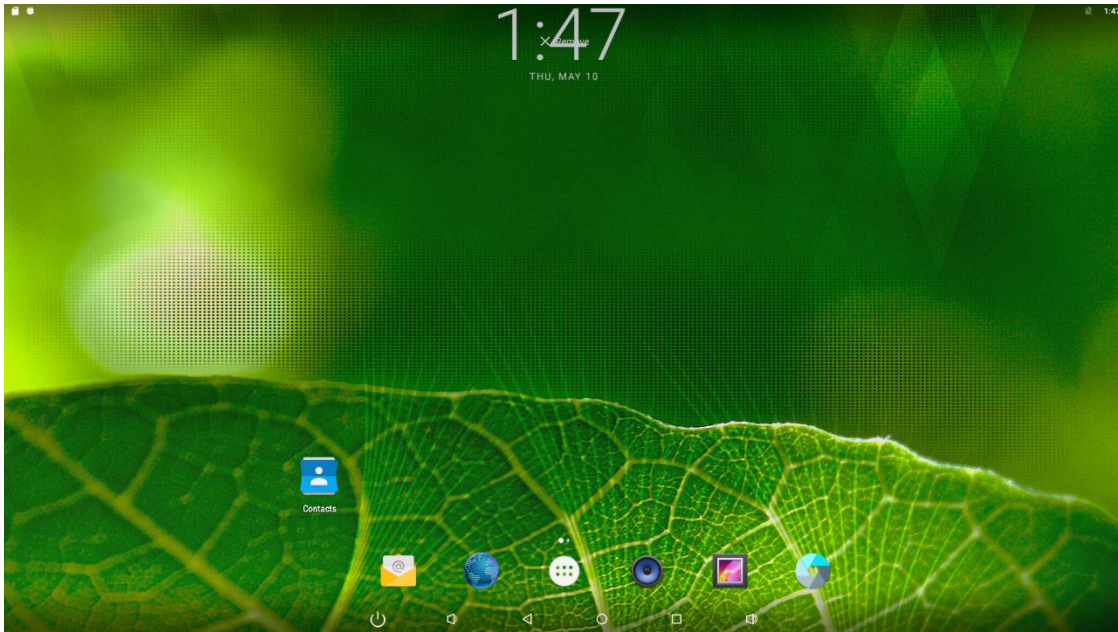

System Bar

Navigation Buttons



- 1. Power off:** Close the device
- 2. Volume-:** Decrease the system volume.
- 3. Back:** Return to the previous page.
- 4. Home:** Return to the home screen.
- 5. Recents:** Switch between recently used apps.

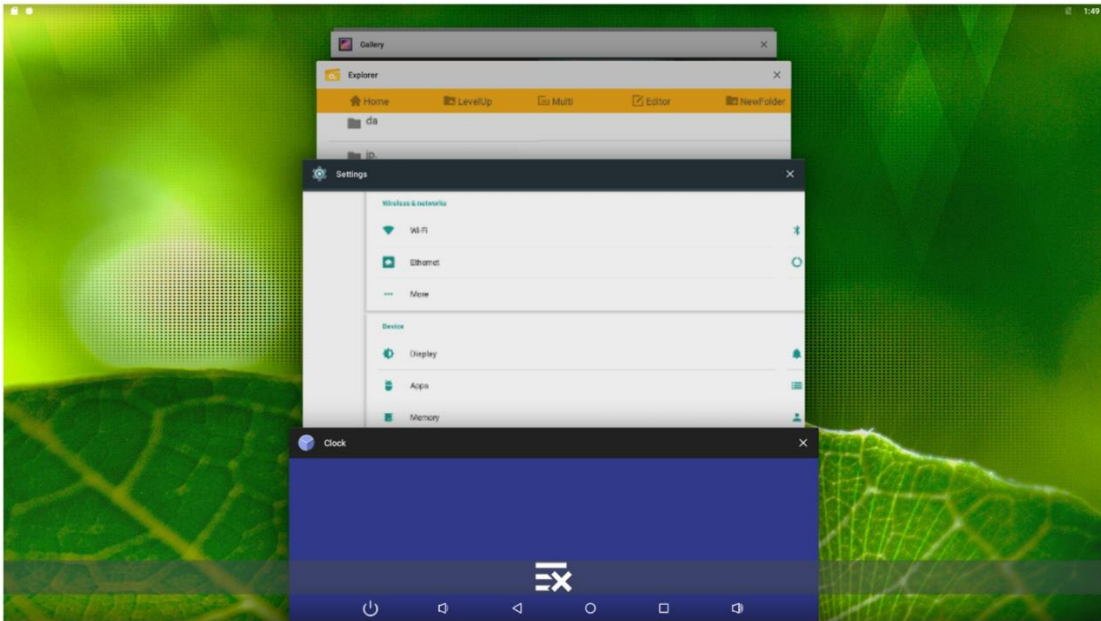

To delete an application from the list, you can delete the application by clicking on the "X" icon in the upper right corner or Left and right removal.

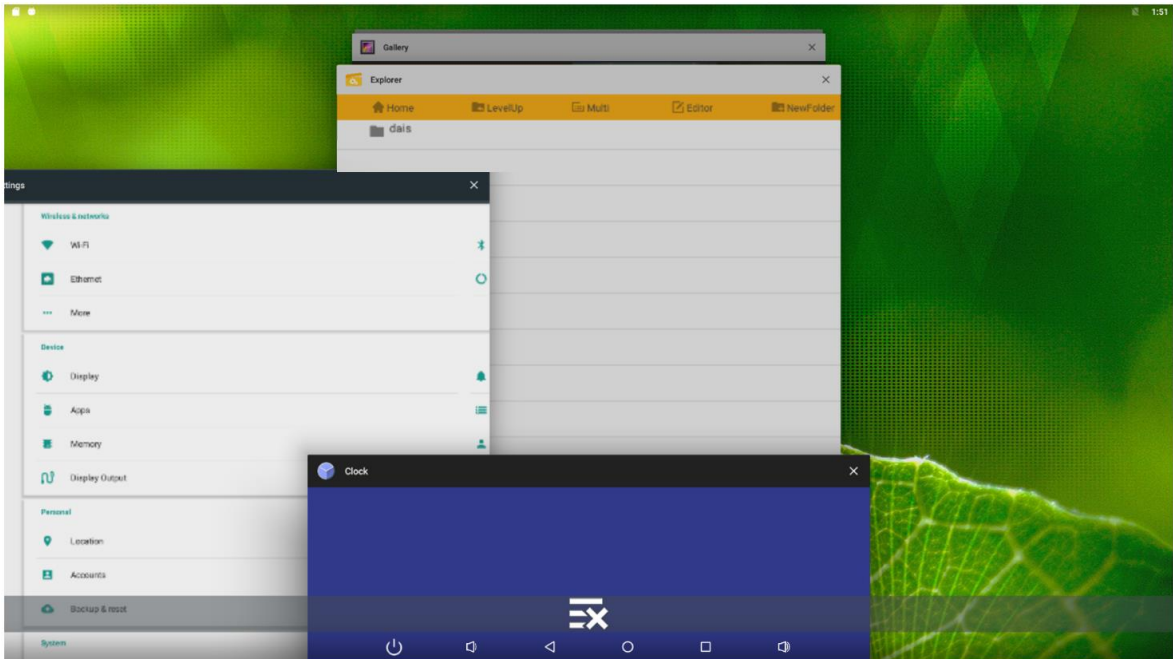

Click the middle X icon to delete.

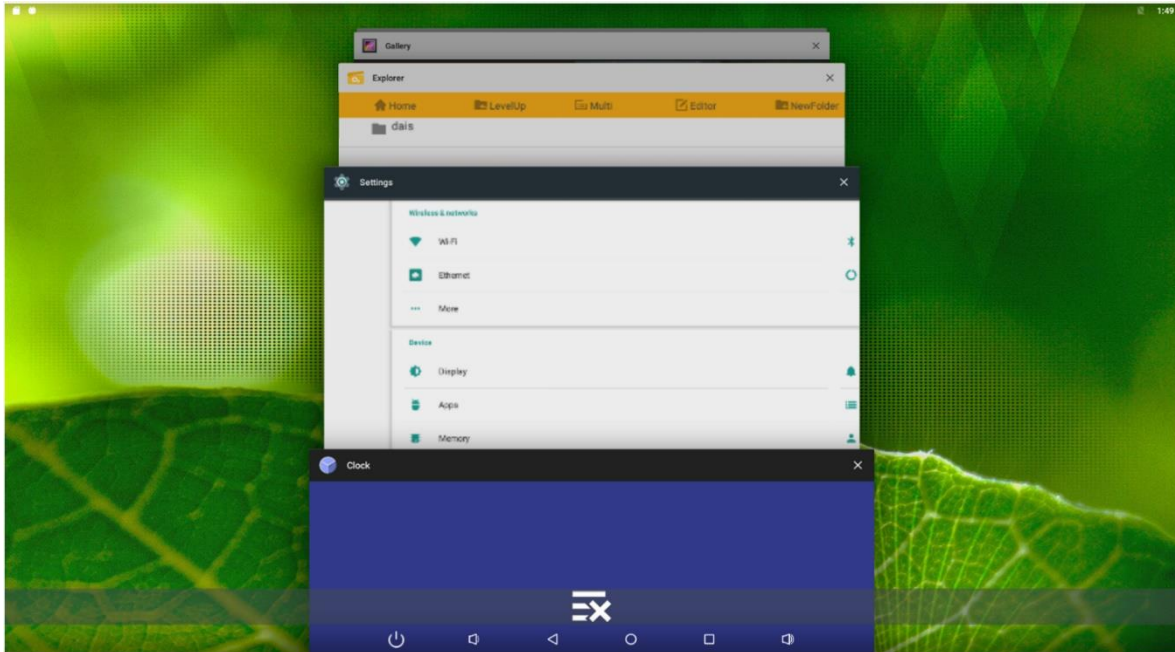

6. Volume+: Increase the system volume.

Status Notifications

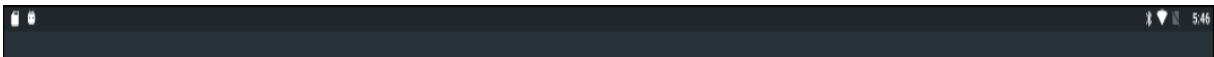

Status bar at top of the screen displays system status, such as time, Wi-Fi, Bluetooth, SD card and USB connection etc.

Pull down from top left or right corner, open the status window and shortcut window, including brightness adjustment, wi-fi, Auto-rotation, Bluetooth, Cast, Airplane mode, Location and Power off.

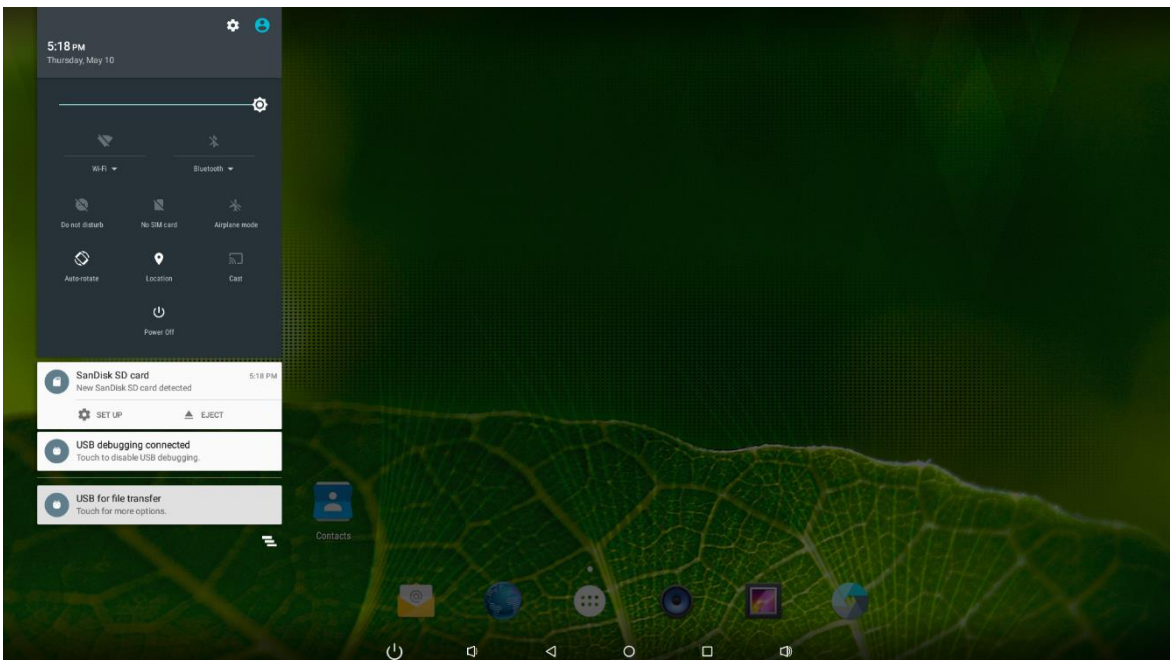

Applications

Click  at the bottom of home screen to enter the applications page.

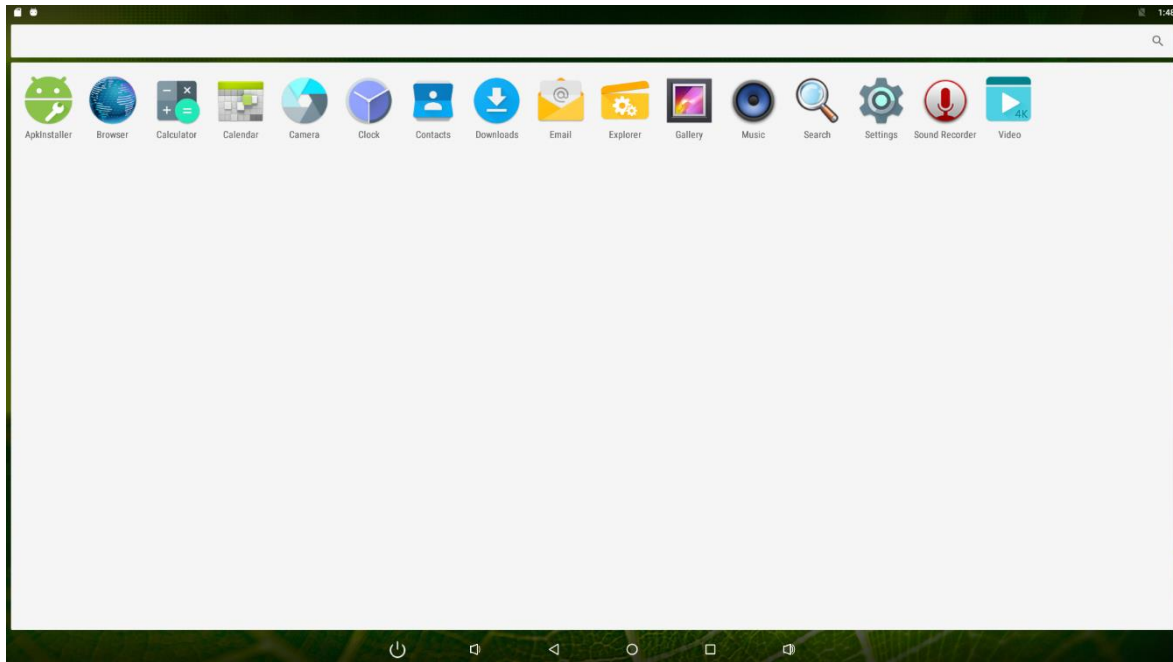

The installed applications will be shown here and you can open an app by clicking its icon.

To find an app easily, you can create a shortcut by long-pressing of the icon and drag it to the home screen.

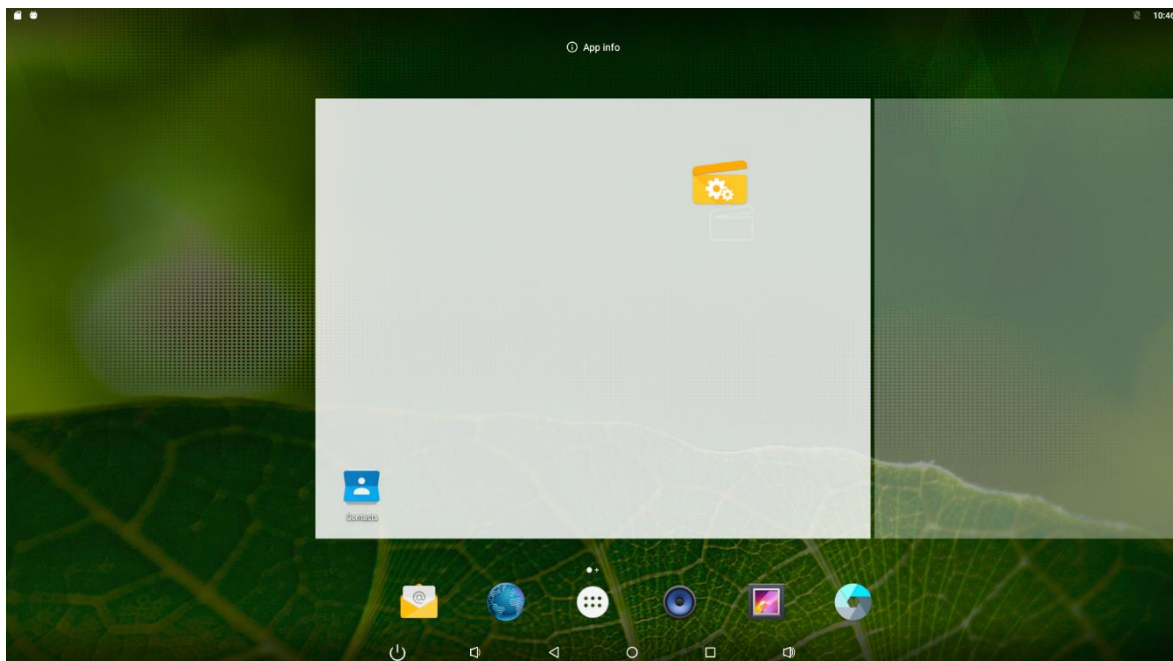

Language

In the App list, click “**Settings**”  to open the system setting app, and select the option “**Language & input**”.

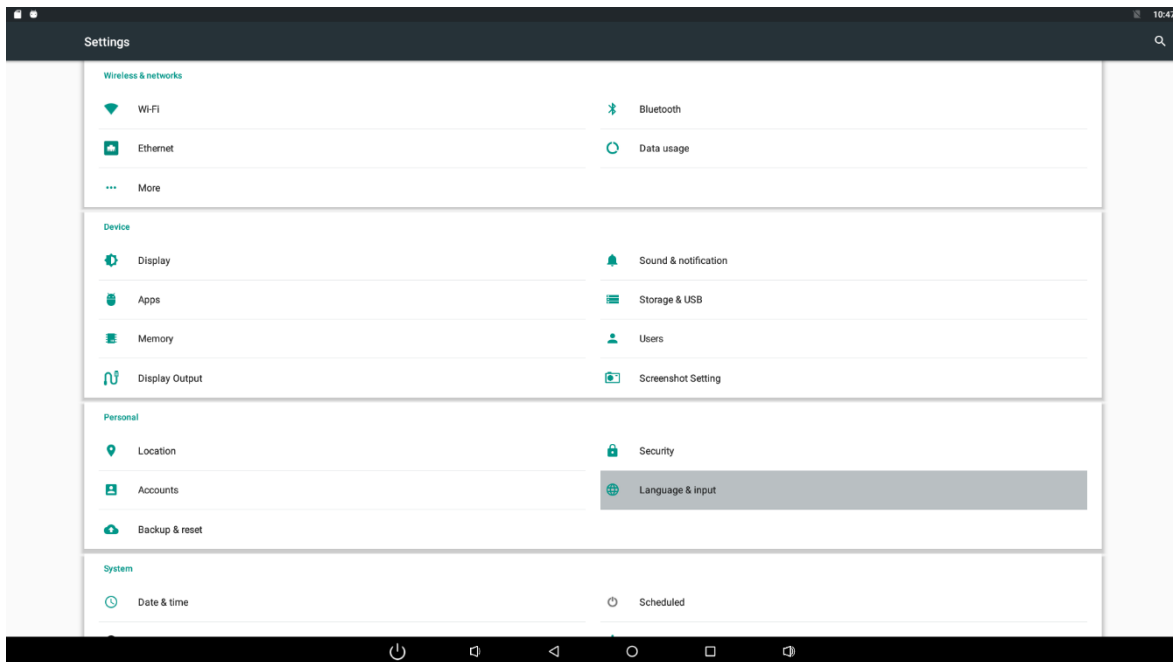

Click the first option “**Language**” under “**Language & input**”, and then you can change the system language according to your preference.



Date & Time

In the App list, click “**Settings**”  to open the system setting app, and select the option “**Date & time**”.

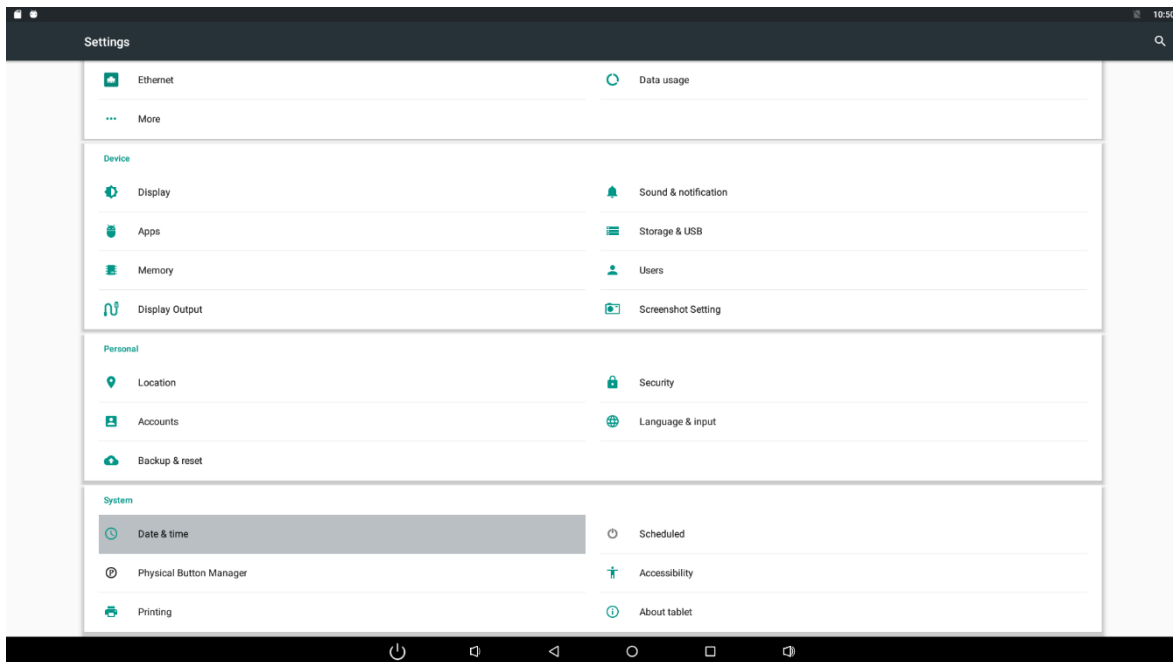

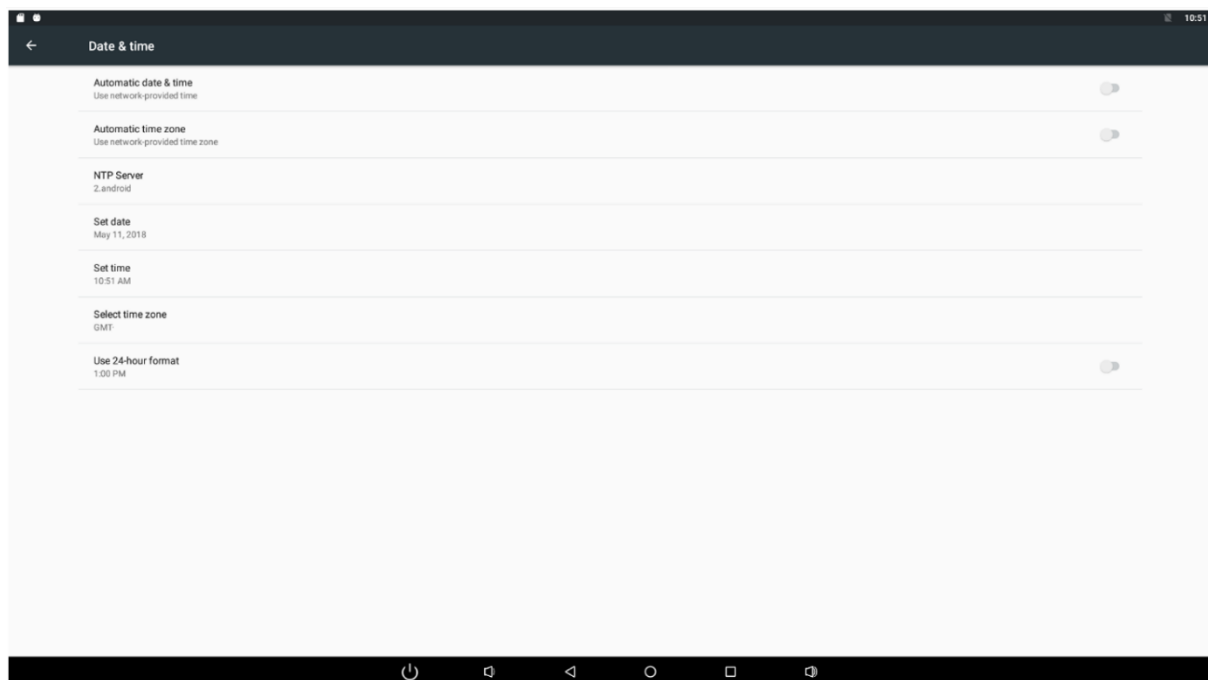

If you enabled the option “**Automatic date & time**” under “**Date & time**”, system date and time will be synchronized automatically with network time when you connected a Wi-Fi network.

If you want to set the time manually, you need to disable “**Automatic date & time**” and “**Automatic time zone**”.



In this option, you can also set time zone, time notation and date format.

Volume

On the system bar, click the **Volume-** icon  to decrease the system volume, and click the **Volume+** icon  to increase the system volume.

Or you can press the function keys (#6 in [Product Instruction](#)) on the top of the product to adjust the volume.

Brightness

Pull down the upper left corner or upper right corner of the screen, open the shortcut key window, and slide the top corner "brightness" progress bar.

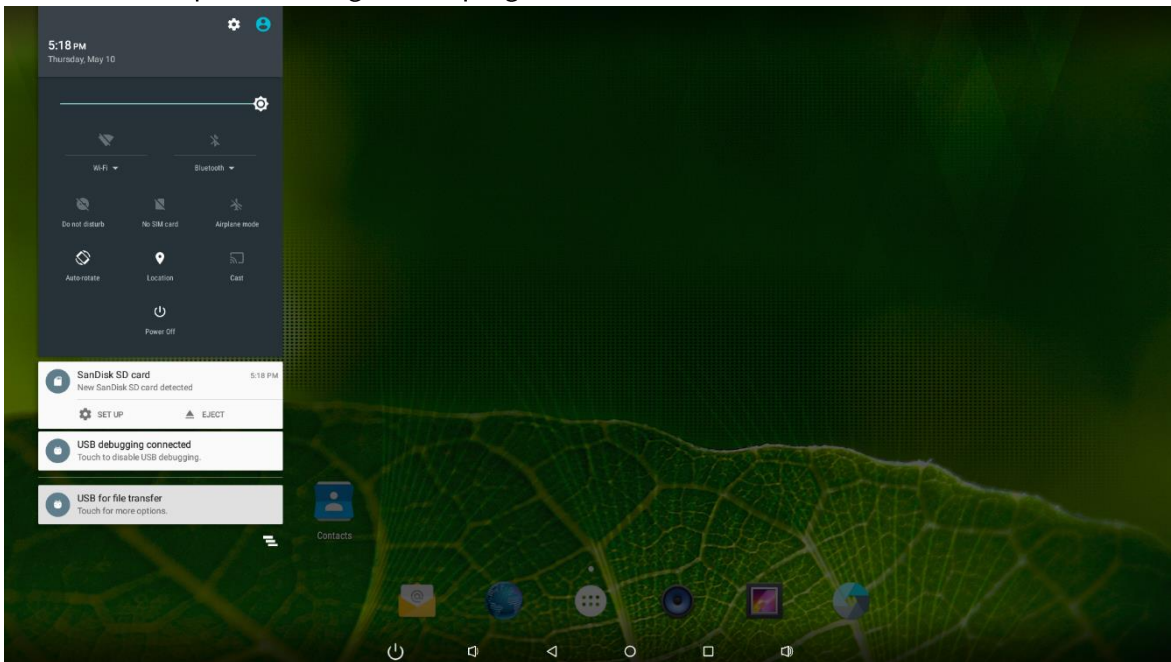

Left and right sliding brightness bar to adjust brightness.



Scheduled

This feature is used to power off, restart, and automatically turn on and off devices at set times.

In the App list, click “**Settings**”  to open the system setting app, and select the “**Scheduled**” option.

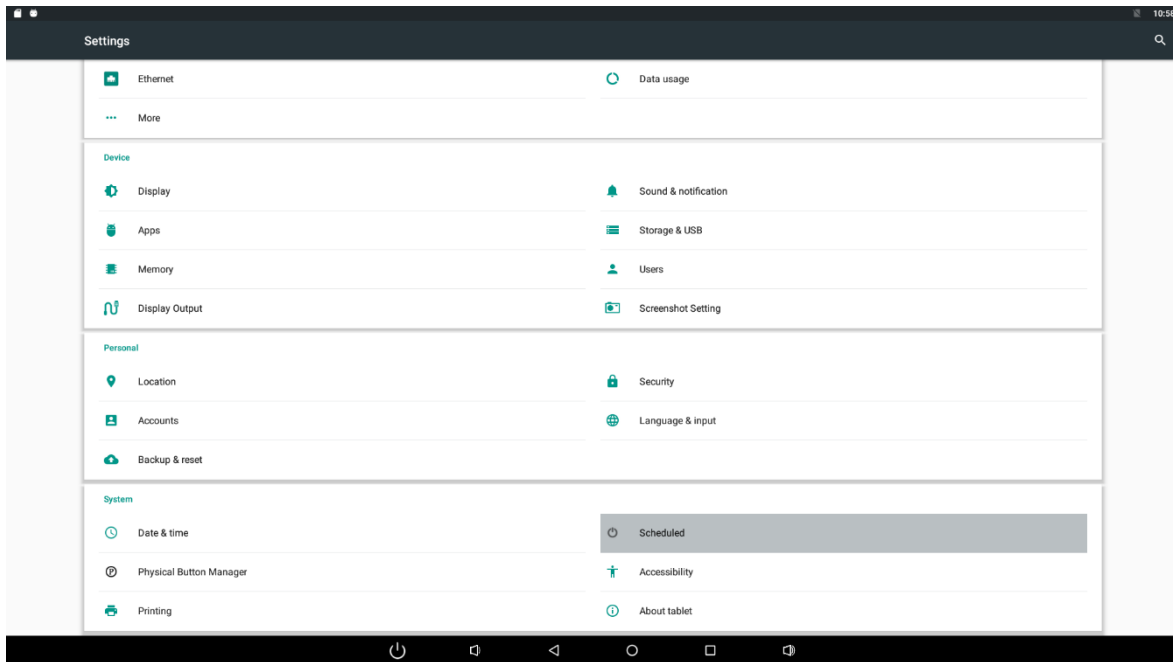

Click the single option “**Shut Down**”.

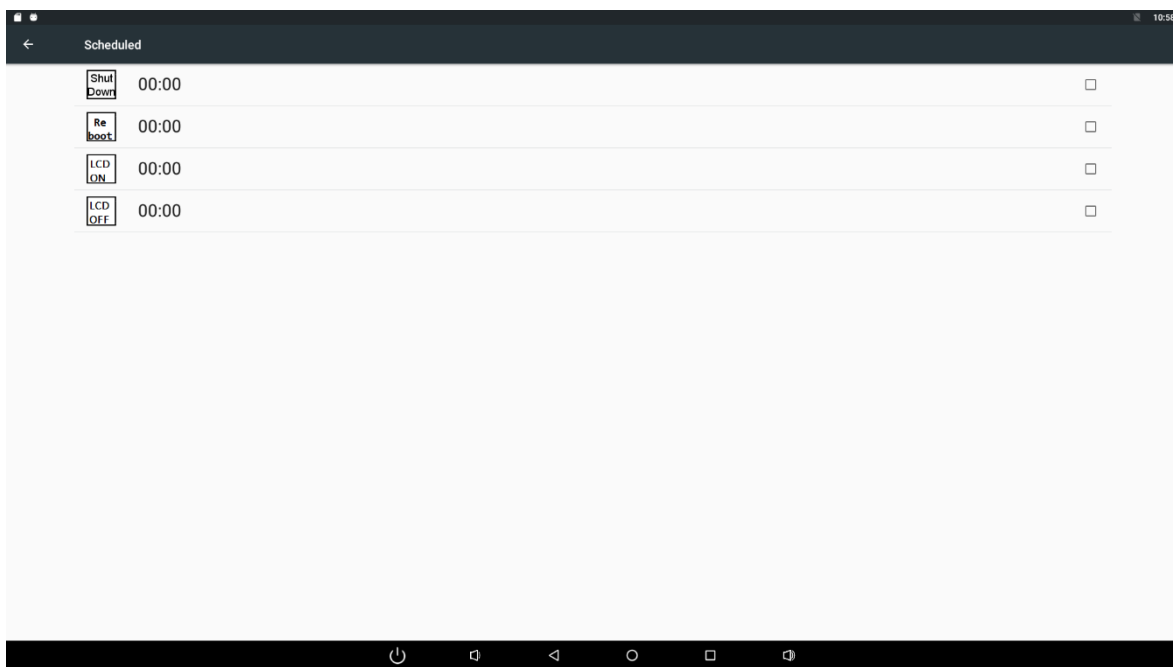

Click the option “**Time**” to set the shutdown Clock time of this device.

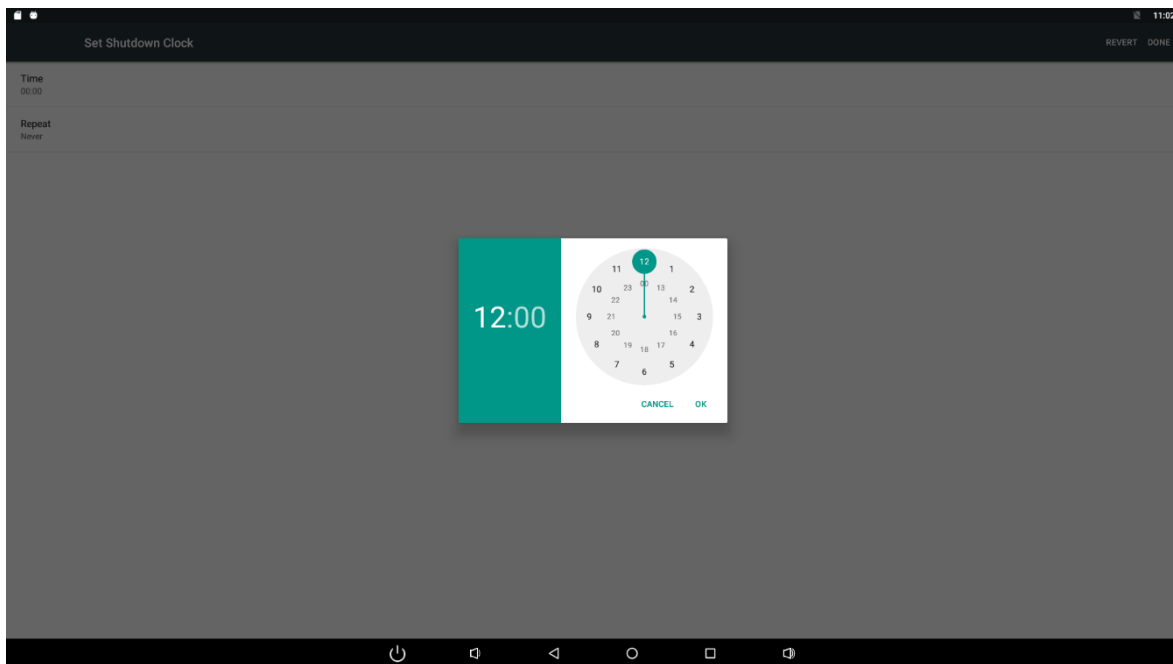

Click the option “**Repeat**” to select the days which will shutdown this device at the set time.

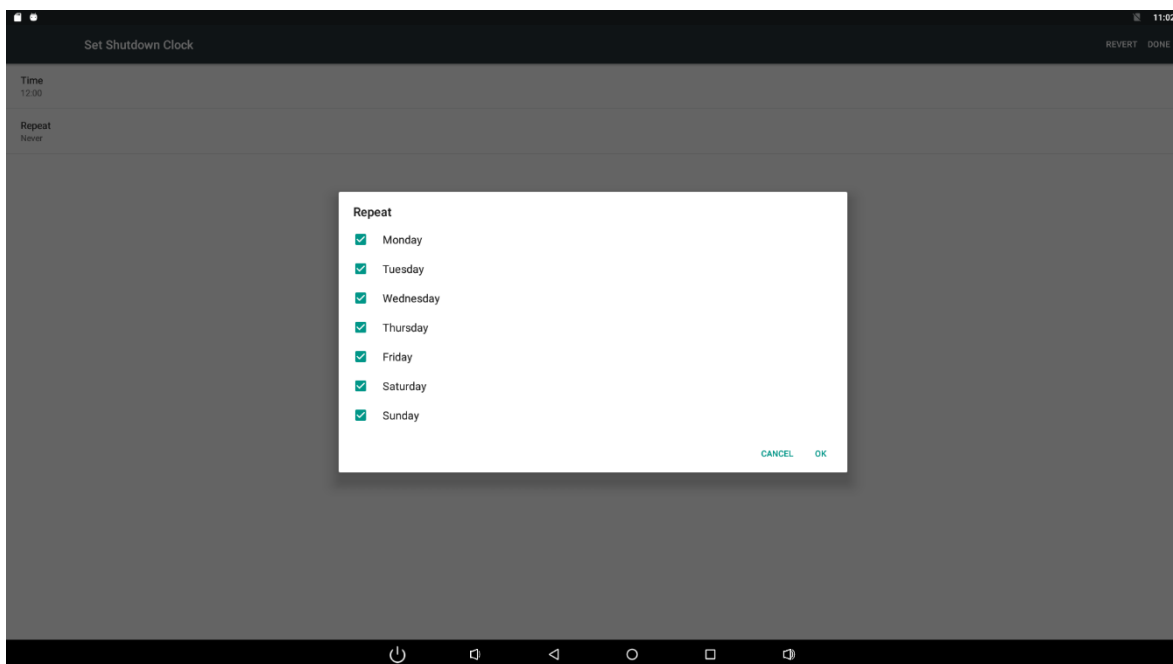

After setting, click “**Done**” at the upper-right corner of the screen to save them.

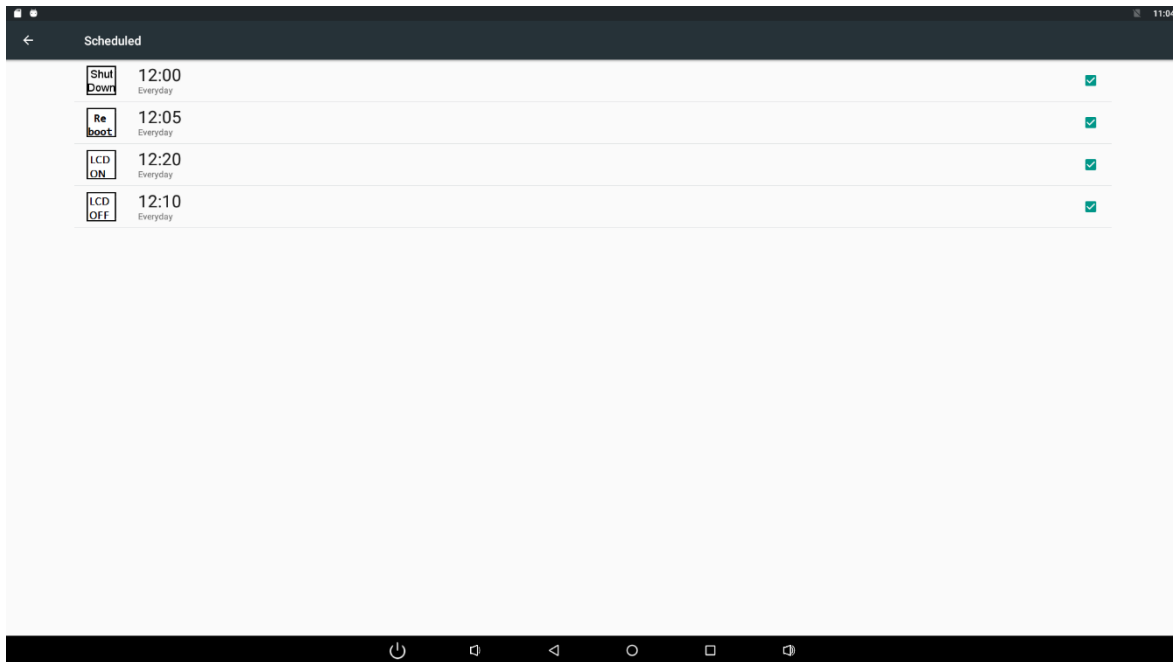

According to the above settings “**Reboot Clocks**、**LCD ON Clocks**、**LCD OFF Clocks**”. LDC ON time is later than LCD OFF time.

You will see the “Reboot、LCD ON、LCD OFF” option checked after saving the settings.

After the setting is completed, the device will perform the operation within the set time range.

Wi-Fi

In the App list, click “**Settings**”  to open the system setting app, and select the option “**Wi-Fi**”.

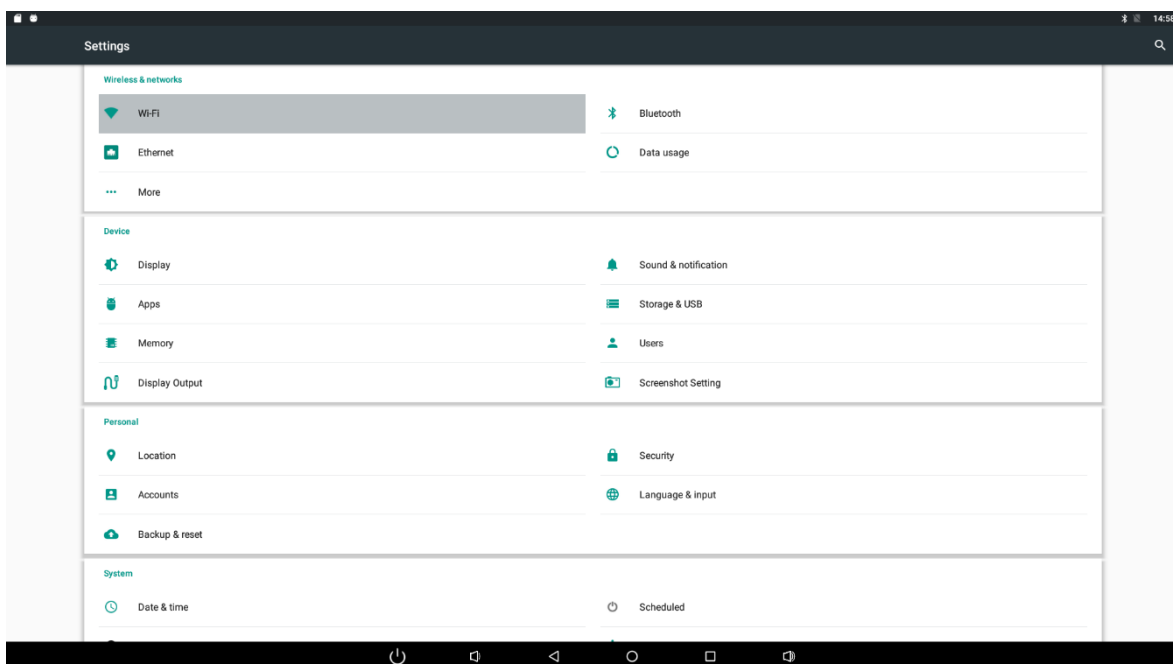

Switch the Wi-Fi button to **ON**. The product will scan available wireless networks automatically.

Select a network under Wi-Fi networks and input the password to connect.



Ethernet

In the App list, click “**Settings**”  to open the system setting app, select “**Ethernet**” option.

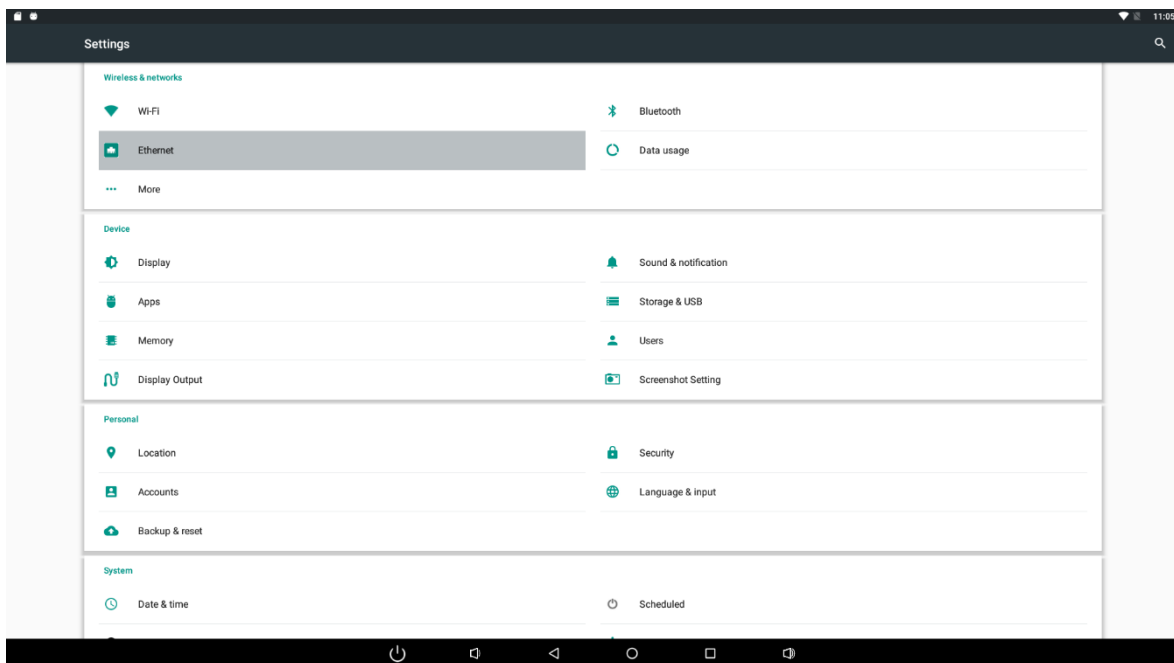

Check “Use Ethernet” and plug the Internet cable into the Ethernet port (#11 in **Product Instruction**). If Wi-Fi is on, please turn off Wi-Fi to allow Ethernet working.



The static and DHCP switch can be performed in the Ethernet IP mode.

Bluetooth

In the App list, click “Settings”  to open the system setting app, and select the option “Bluetooth”.

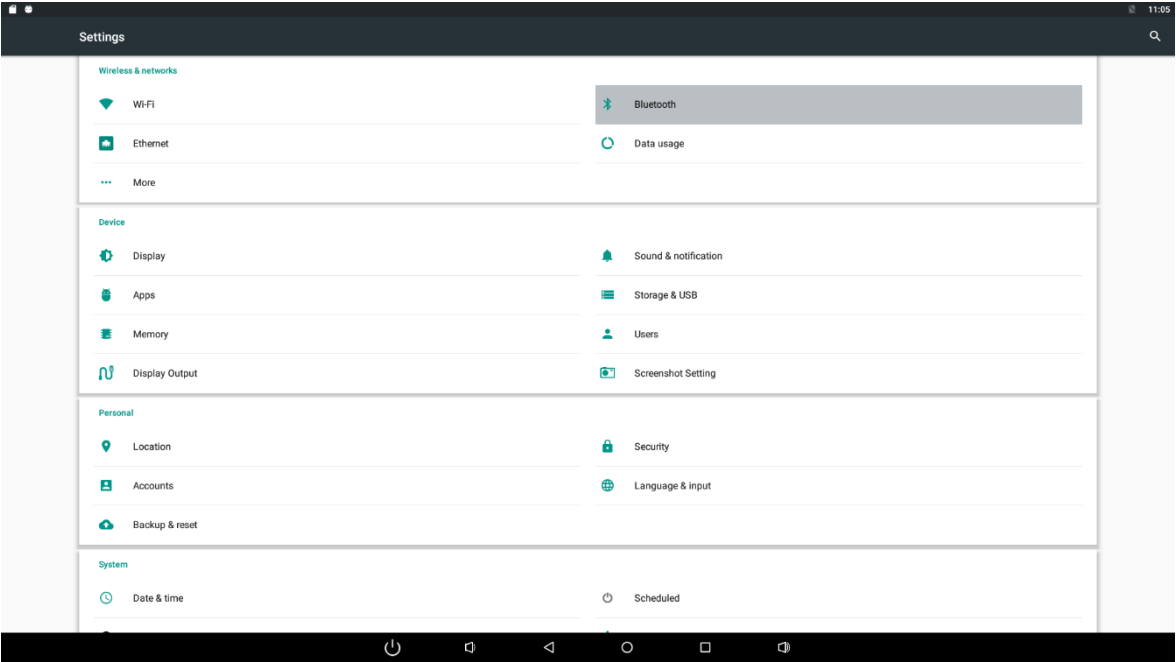

Switch the Bluetooth button to **ON**. The product will scan ambient available Bluetooth devices automatically.

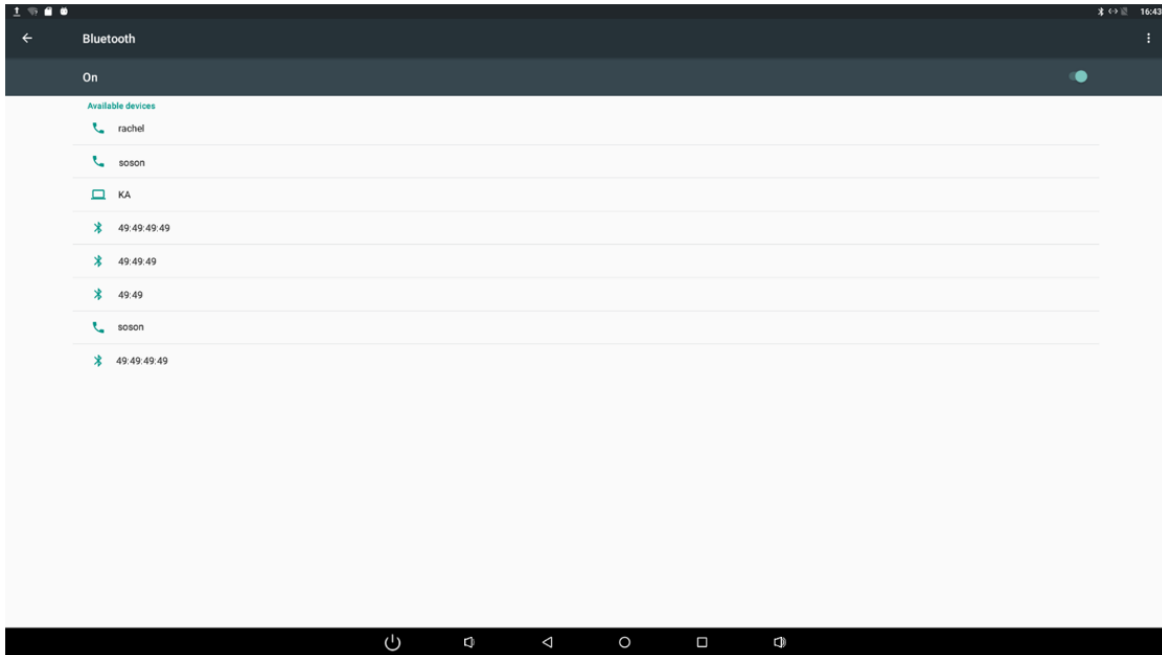

If you want to pair another Bluetooth device, select it from the “Available Devices” list, and then click “Pair” in the pop-up window. At the same time, click “Pair” in the pop-up window of the Bluetooth device to be paired.

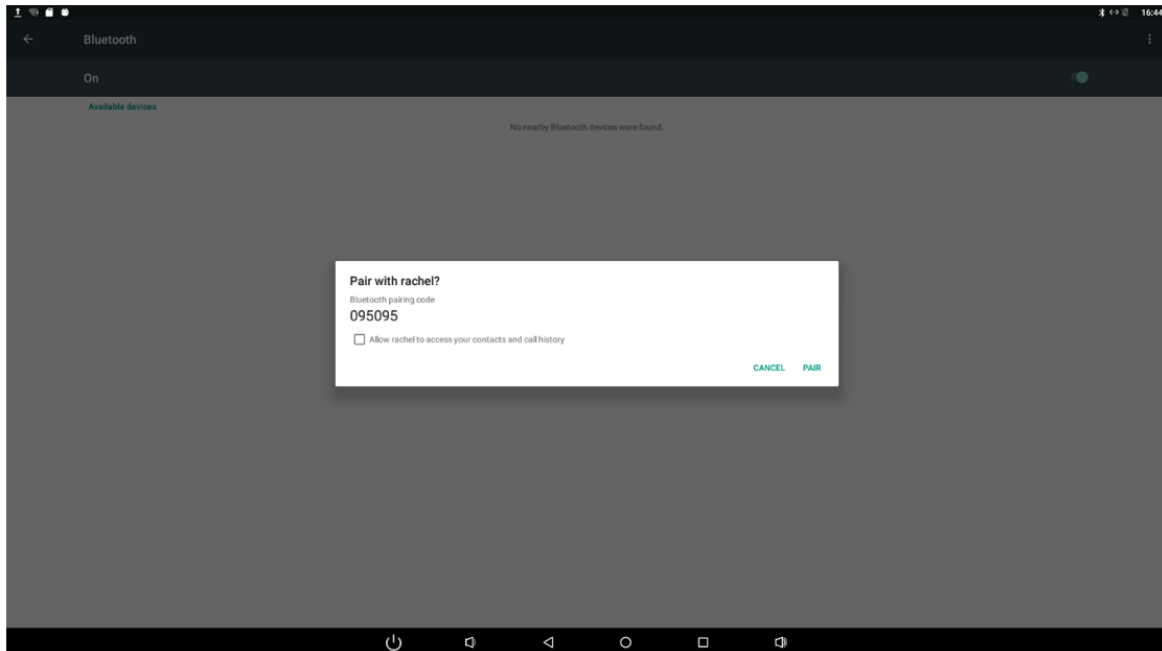

After pairing, the paired device will be moved to the “Paired Devices” list.

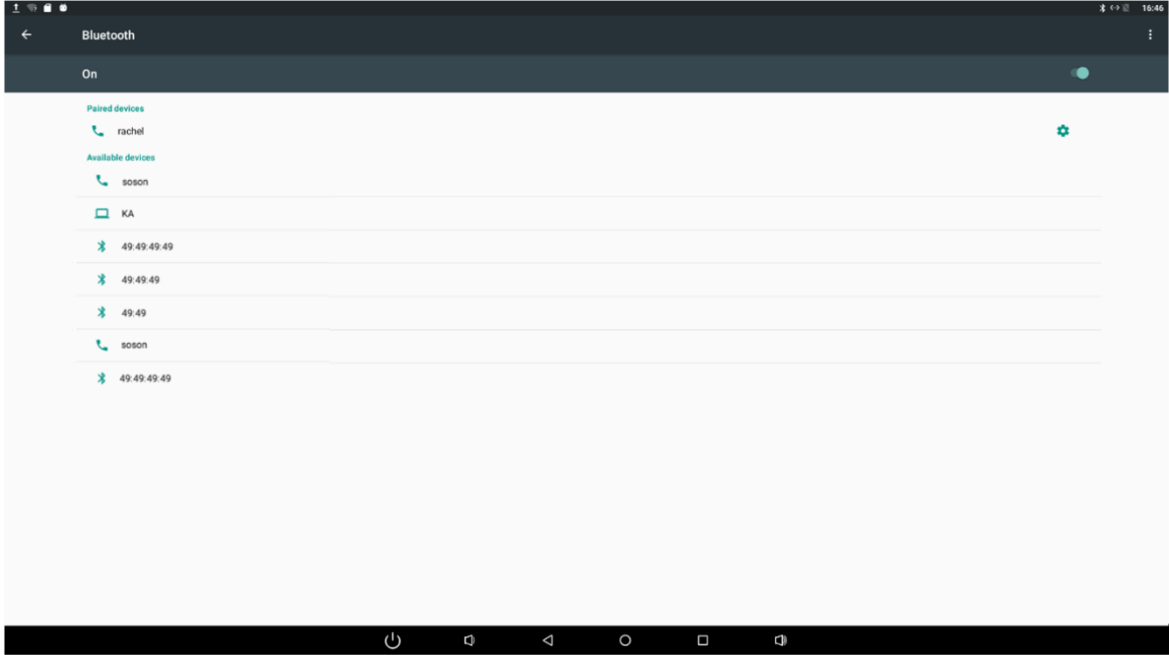

Click the three point icon in the upper right corner to pop up the setting interface, and select refresh, rename this device and show received files.



Virtual Keyboard

The device provides a virtual keyboard for typing. You can use it as a real one.

When you click in a text input box, the virtual keyboard will appear at the bottom of the screen.

To collapse the virtual keyboard, you can click the icon  in the system bar.

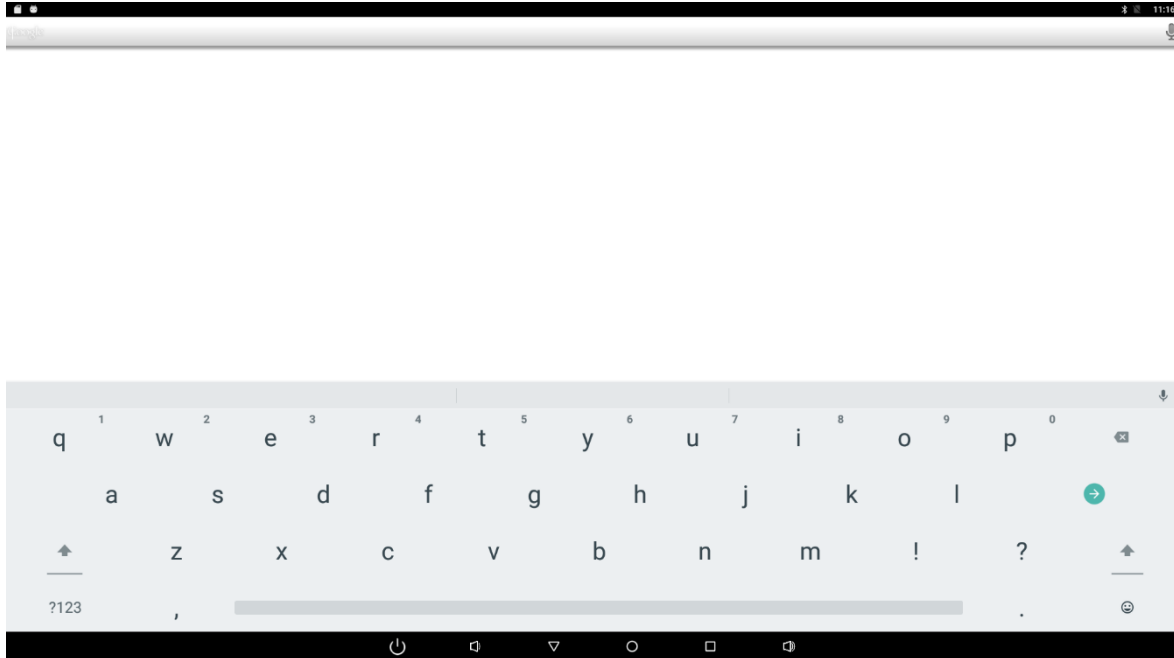

Switch Input Methods

If the keyboard icon is invisible, please check whether the installed input method is selected in the “**Language & input**” option under the system setting app.

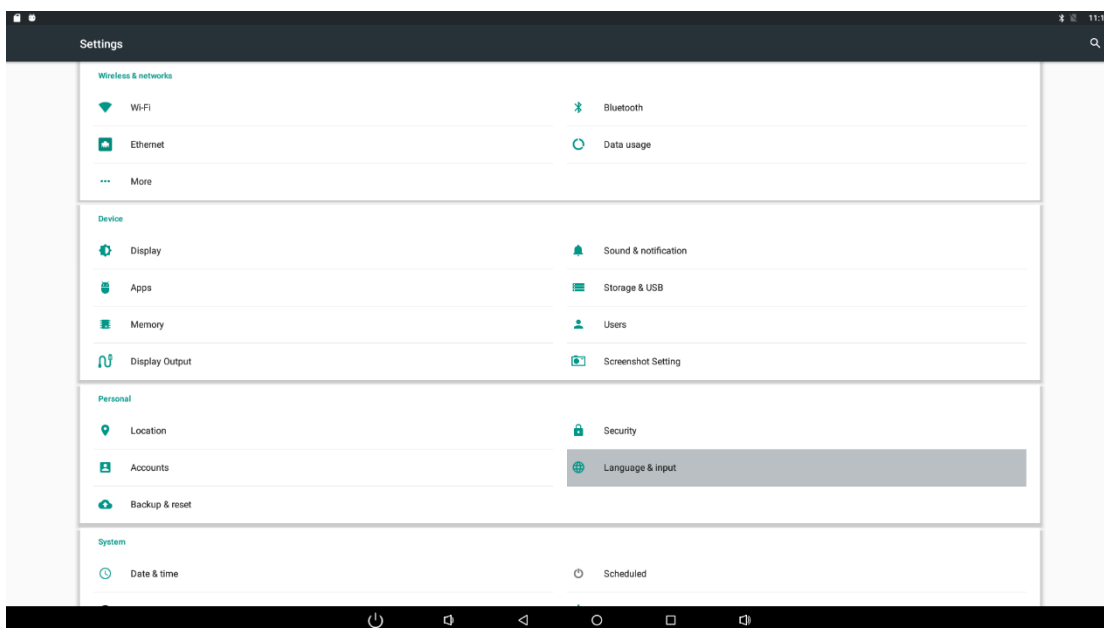

Select Current keyboard option.

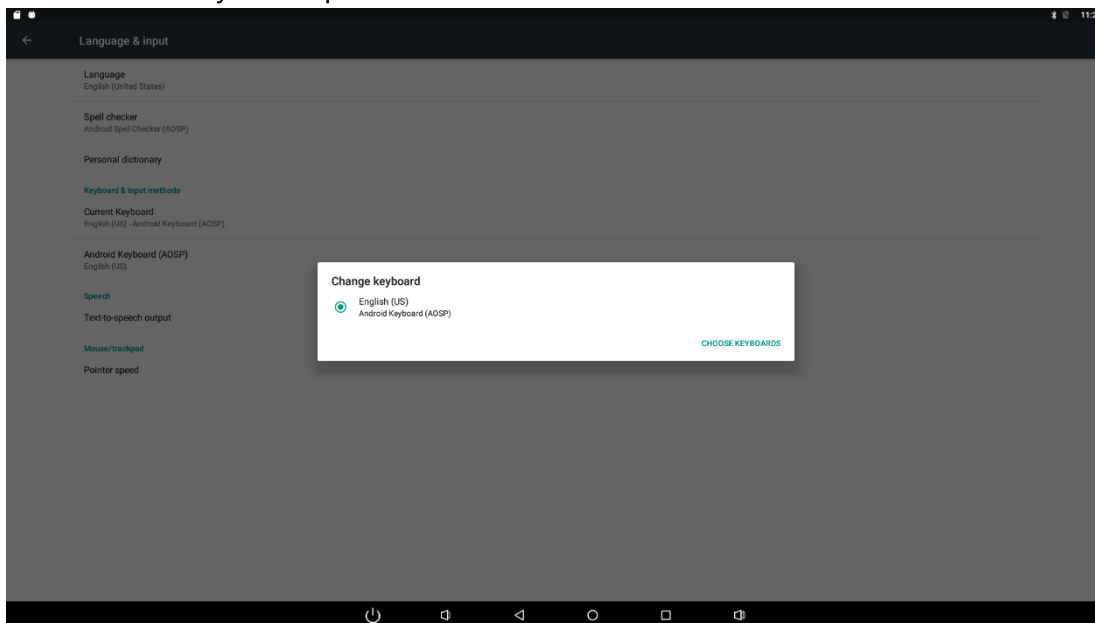

Take Photos & Shots

Front 2M pixels camera is an optional accessory.

In the App list, open “**Camera**” .

Click the capture button  to enter the photo mode.

Click the three icon in the upper right corner to set the countdown, grid reference, flash.

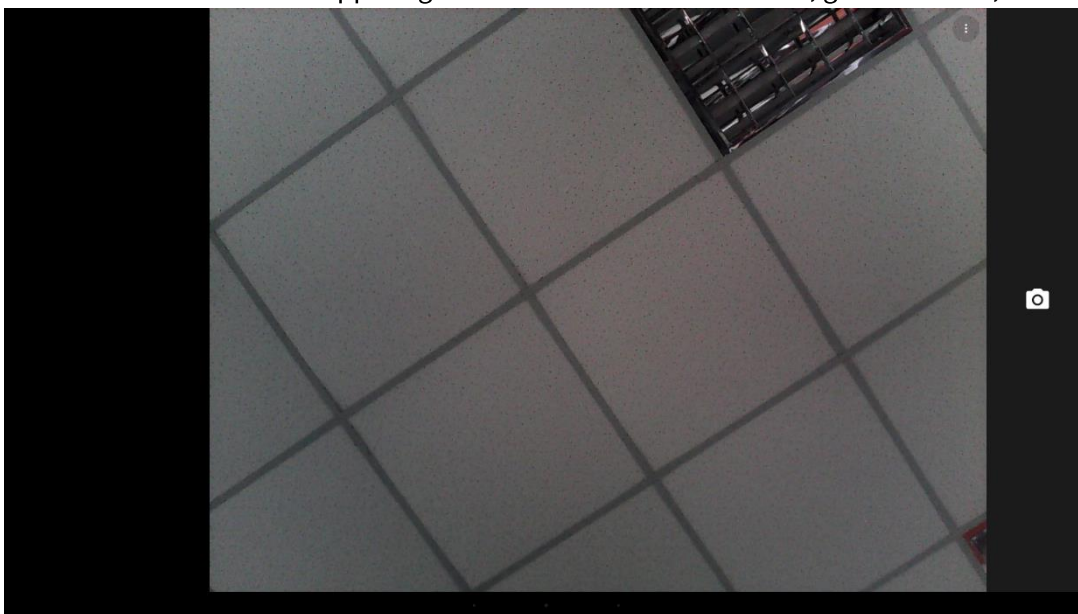

Click the capture button  to take a picture.

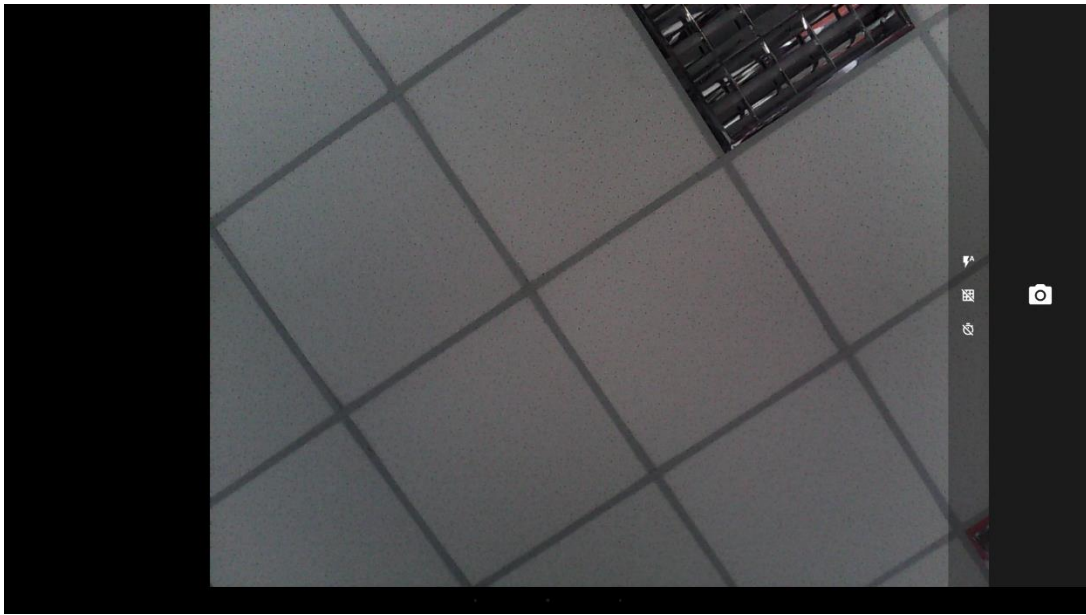

Video can be set up by the following operation method;

Slide the screen from left to right to select video.

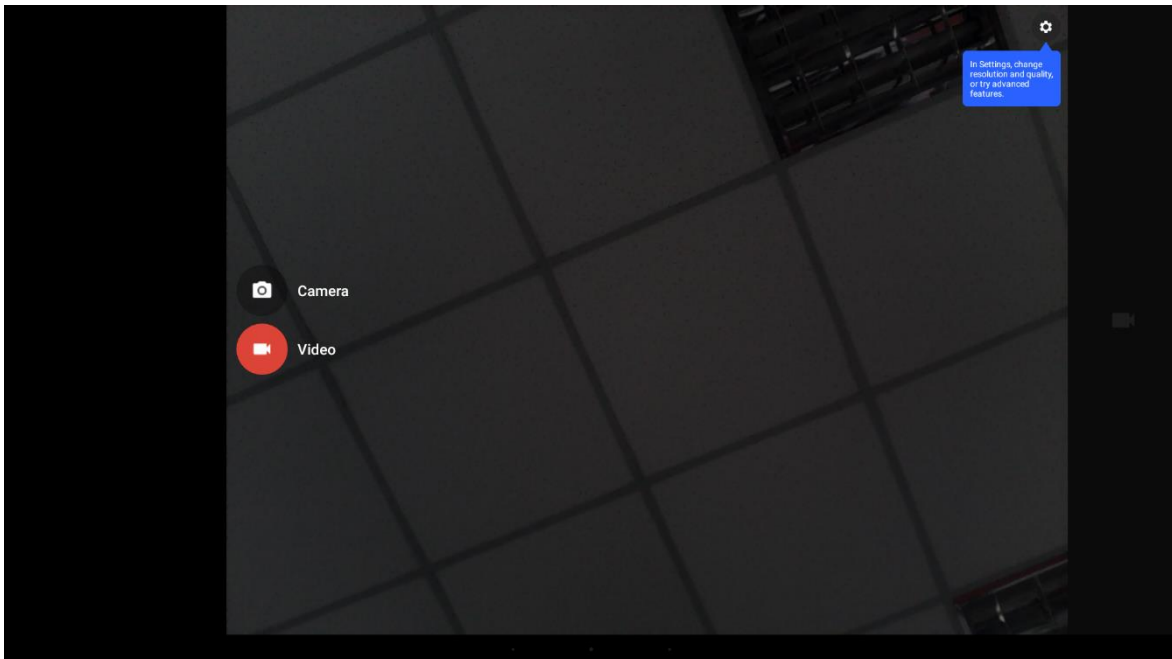

Click the video button  to enter recording a video.

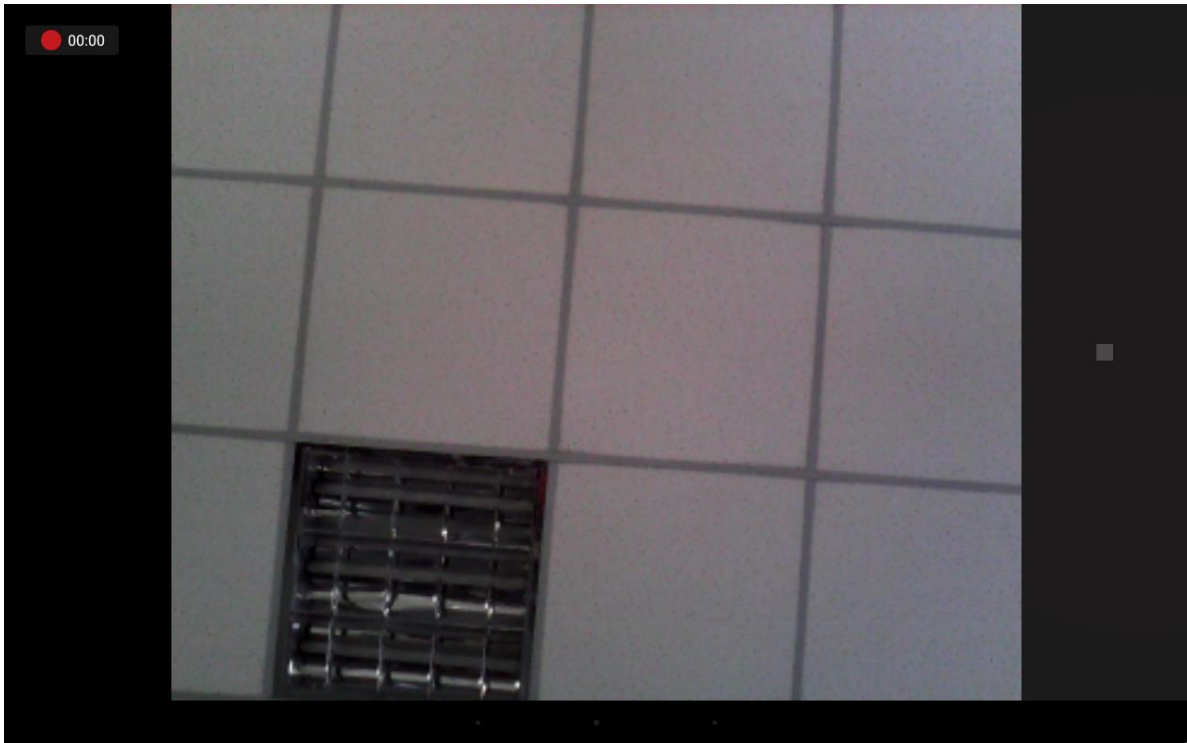

Click the capture button  to stop the shot.

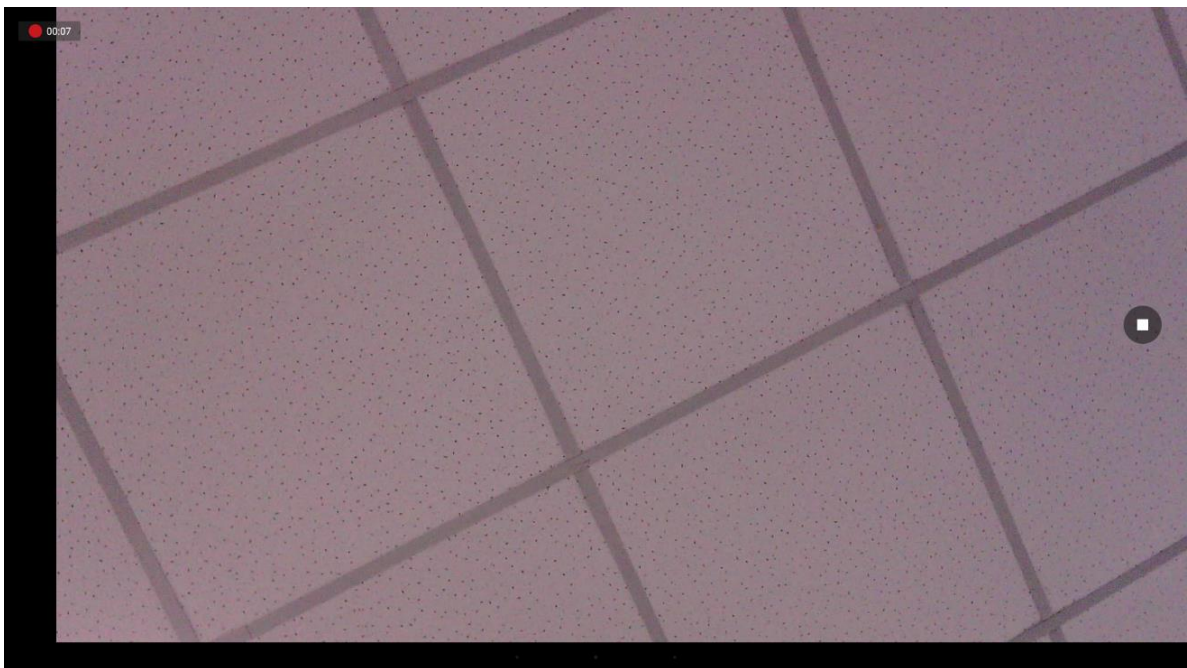

Surf Online

In the App list, open “**Browser**” .

When connecting the device to a network, you can visit websites, play online media or download files via the browser.

In a browser window, enter in a URL in the address bar and click “**Go**” in the virtual keyboard to go. You can also click  to add new tabs to make multiple tabs opened simultaneously.

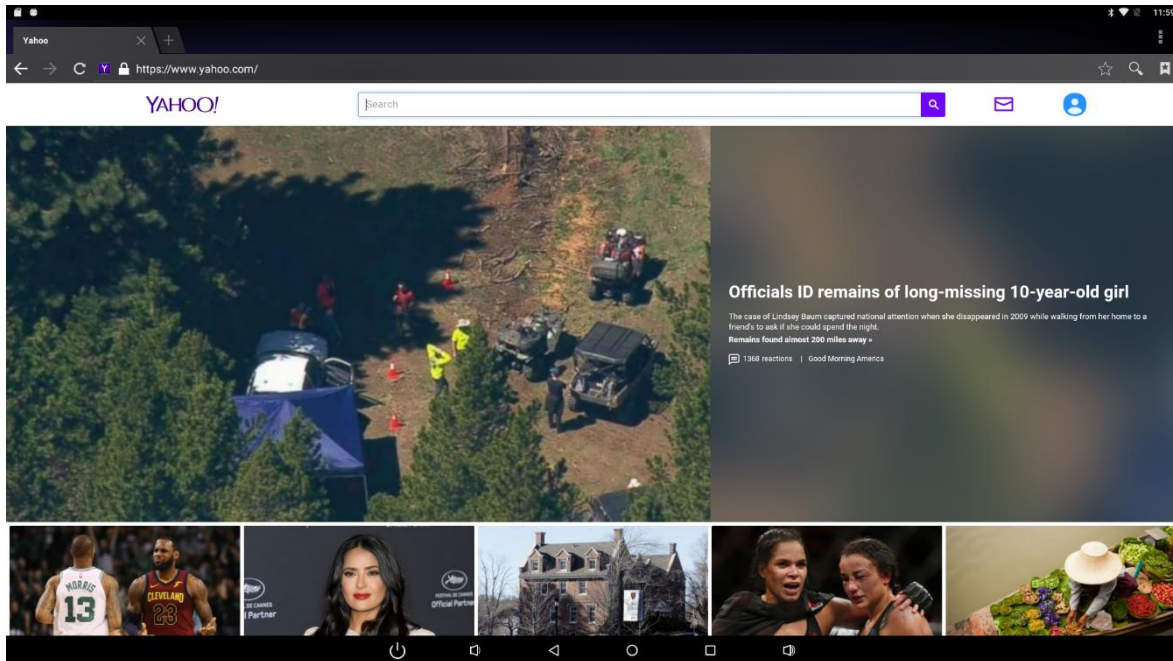

Browse Files

In the App list, open “**Explorer**”  to view local files.

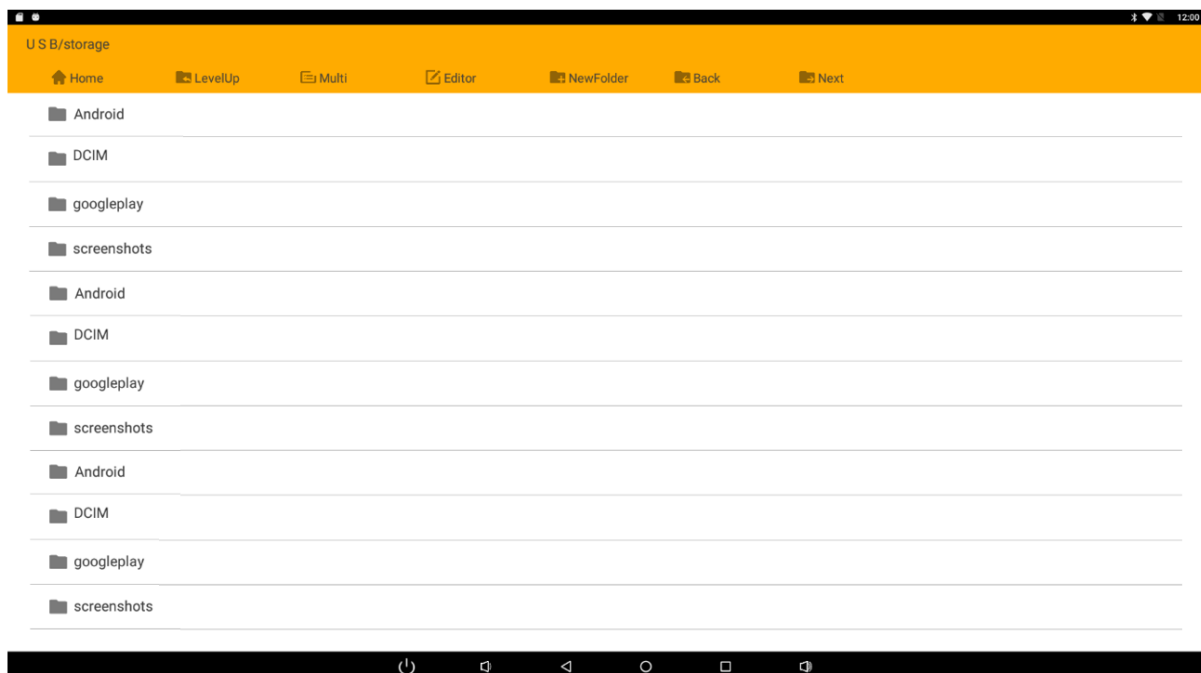

Long-press a file or folder to do file operations, such as copy, delete, move (cut), paste, rename, send (share) and create shortcut.



If you want to select several files/folders at once, click “Multi” in the menu, and then select files/folders. The selected files/folders will be highlighted in orange.

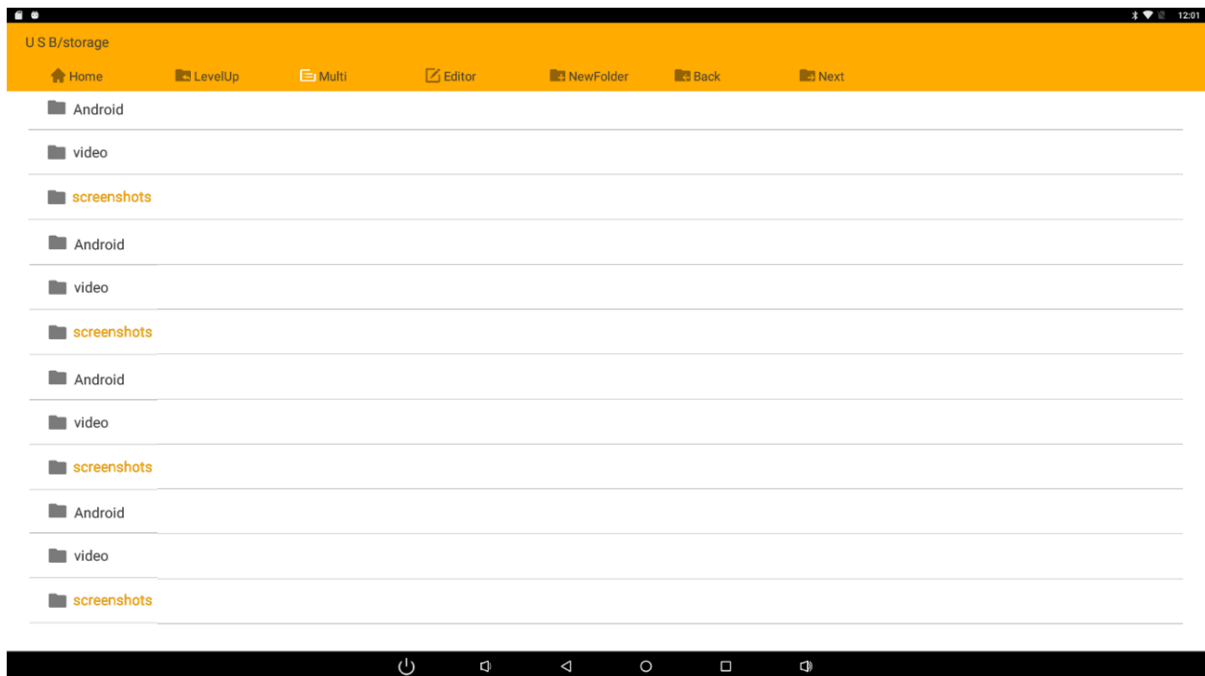

Click “Editor” in the menu to operate the selected files/folders.



Play Media

With the provided apps, you can play your media files on your storage, such as pictures, music and videos.



Gallery Player:

Support JPG, BMP, GIF.



Music Player:

Support MP2, WMA, WAV, AAC, OGG, ASF.



Video Player:

Support MKV, TS, FLV, AVI, VOB, MPG, DAT, ASF, RM, MOV, 3GP, MP4, WMV.

Install & Uninstall Apps

Install Apps

Before installing an app, please download the app (.apk) to via the browser, or copy a downloaded app to the device from your computer.

Then you can open “**ApkInstaller**”  in the App list to install the downloaded app.

First installation prompt “you need grant access READ_EXTERNAL_STORAGE” select ok.

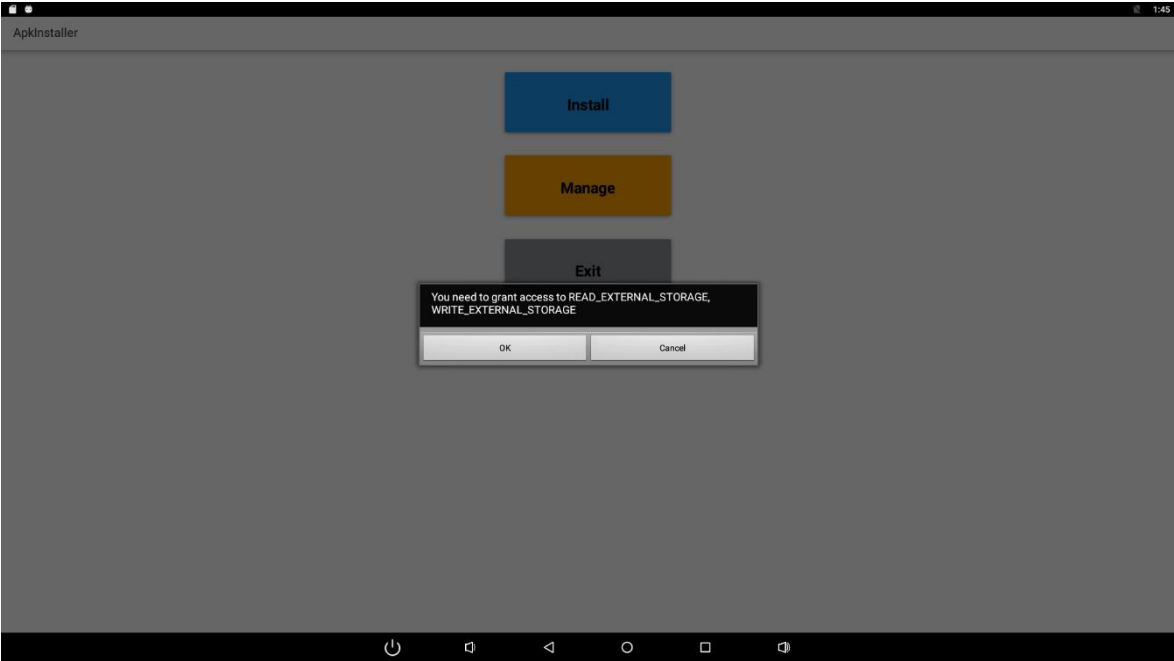

Choose “Allow”.

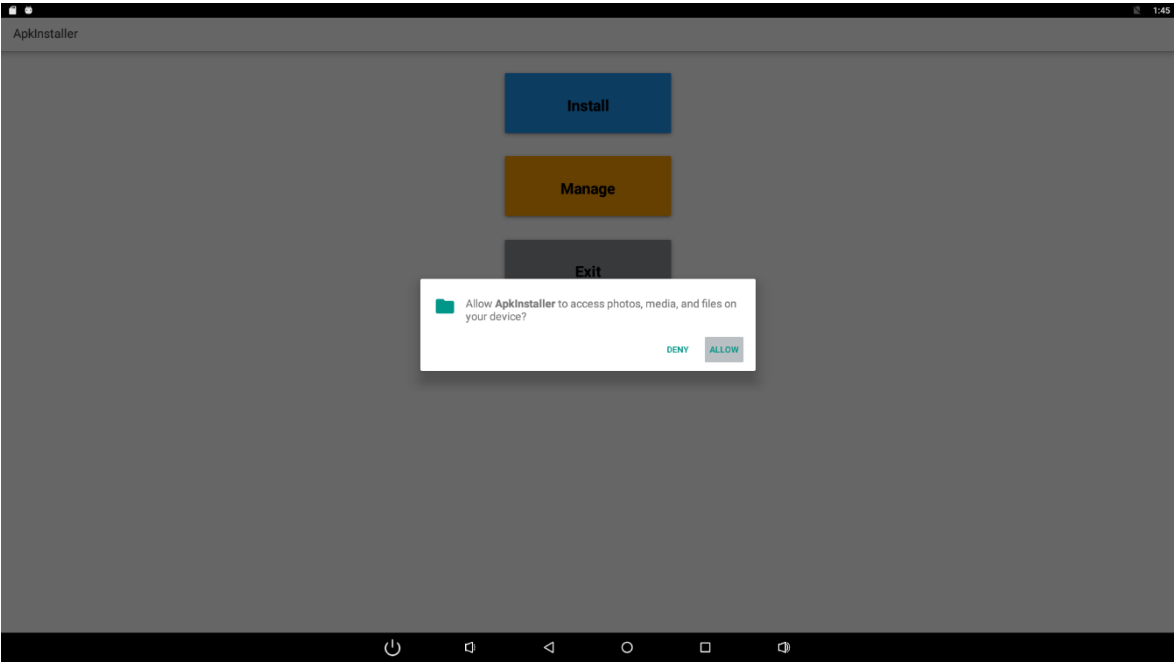

Enter the installation interface and click Install.

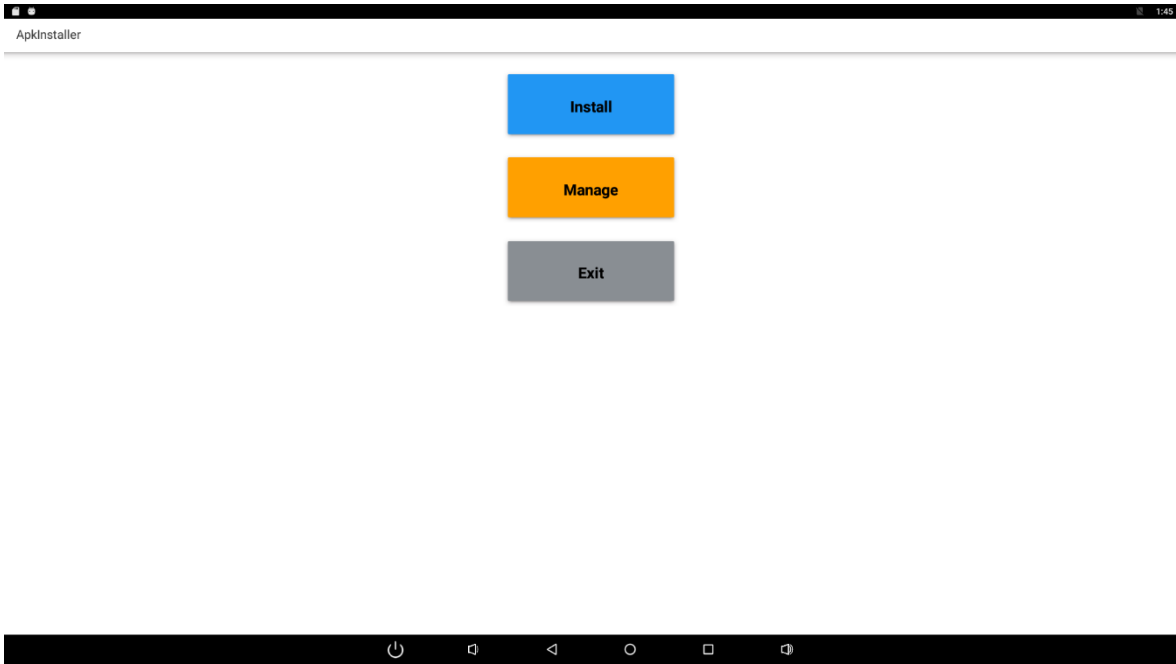

The apk files will be automatically scanned in the right side list; The content shown here is the SD card.

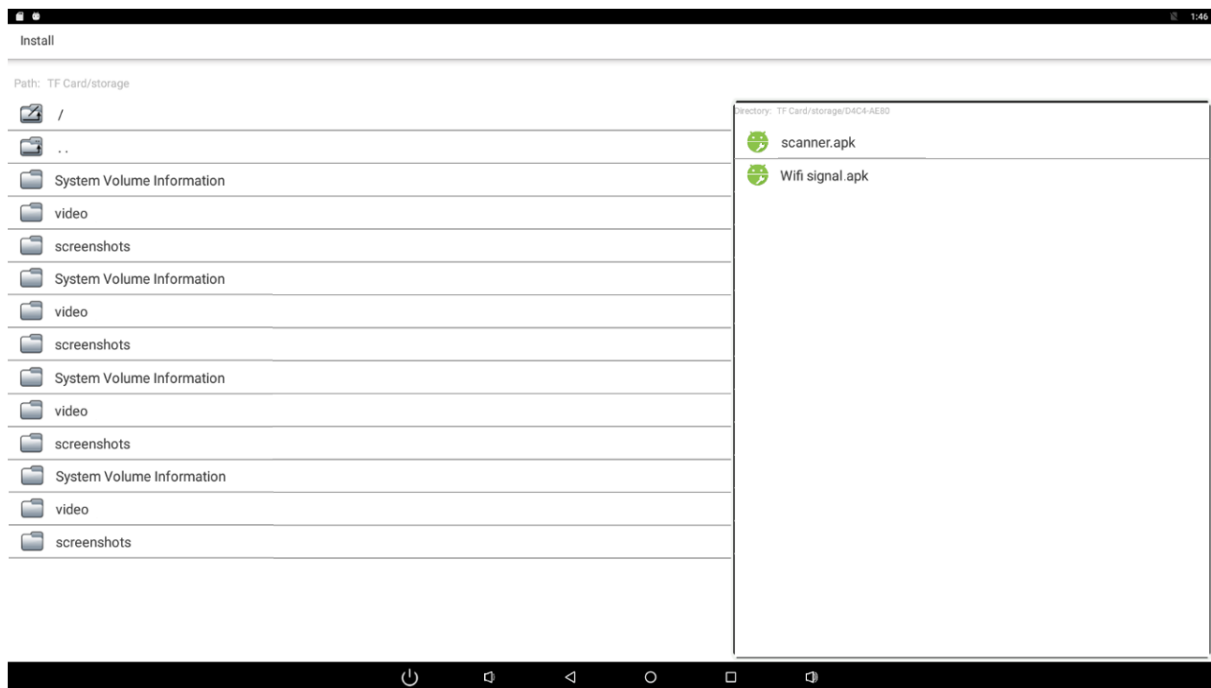

Click the apk you want to install. Click “Install” or “Next” until it turns to “Install”, and then waiting for installation finished.

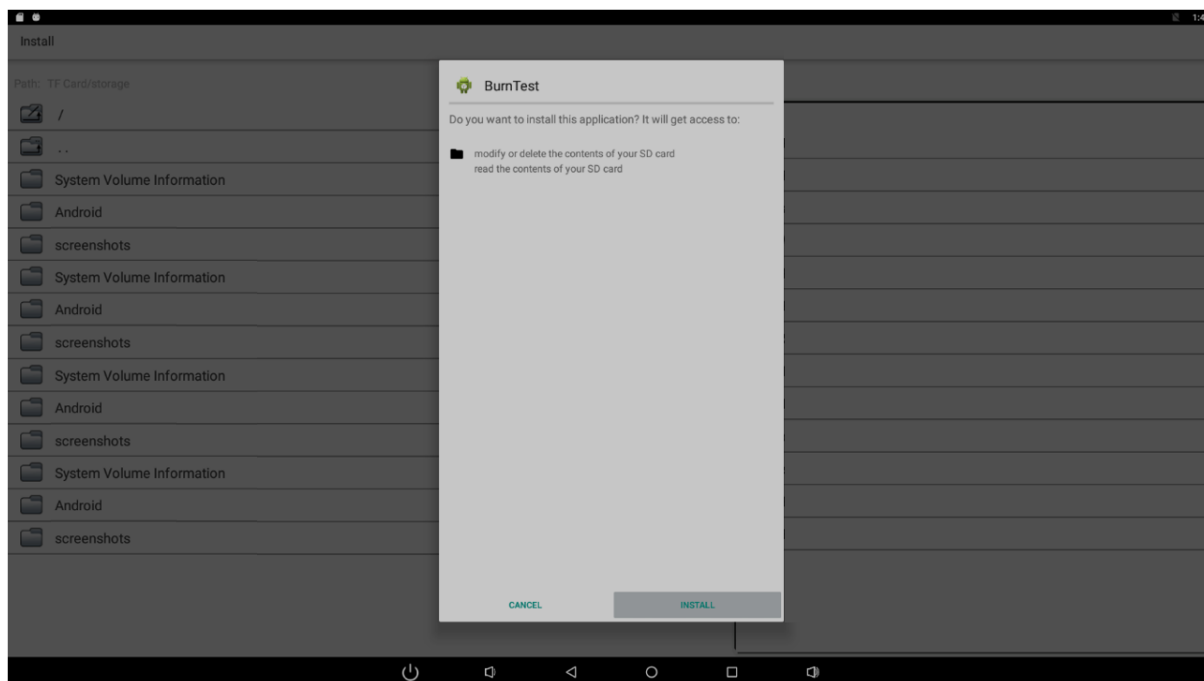

You can also download an android app market, and install the apps via the market.

If “Install blocked” is prompted when installing an app, please open “**Settings**” and select the option “**Security**”, allow “**Unknown sources**” and then back to reinstall the app.

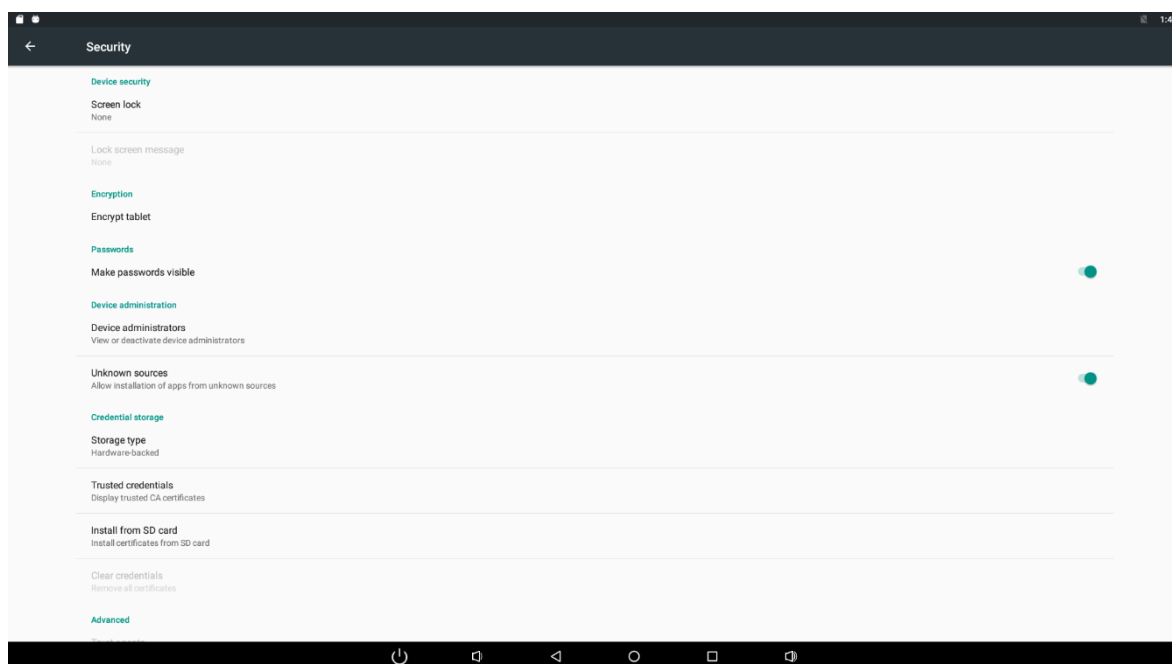

Uninstall Apps

To uninstall an app, please open “**Settings**” in the App list and select the option “**Apps**”. In this option, you will see the installed apps list.

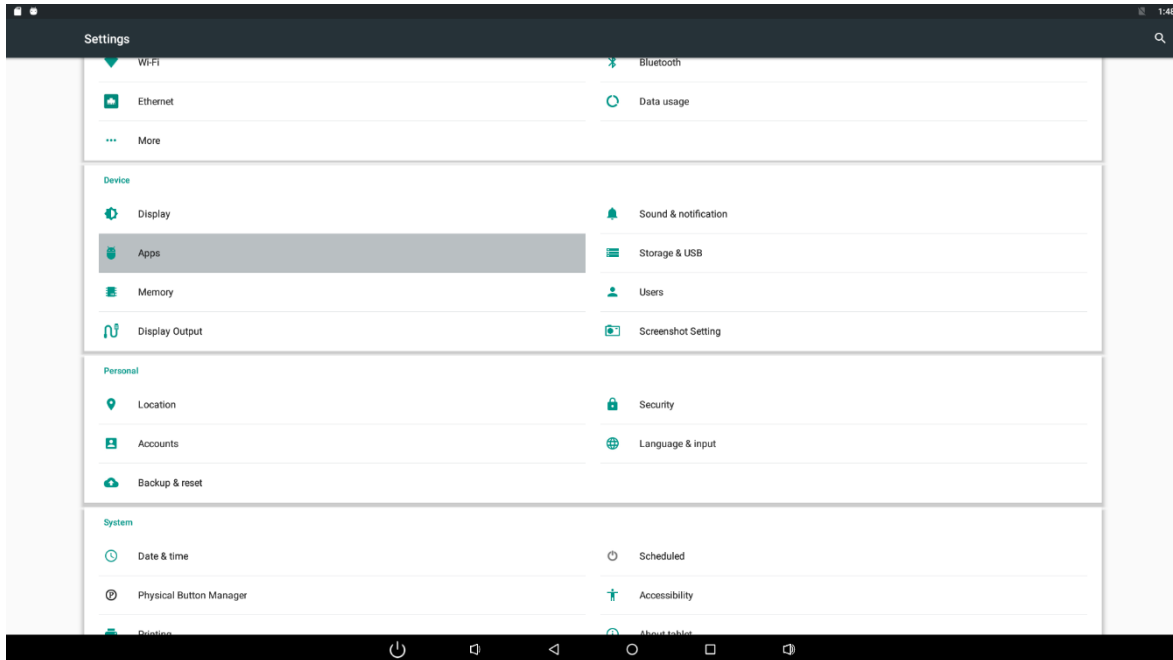

Click the app you want to remove to enter the detail page.

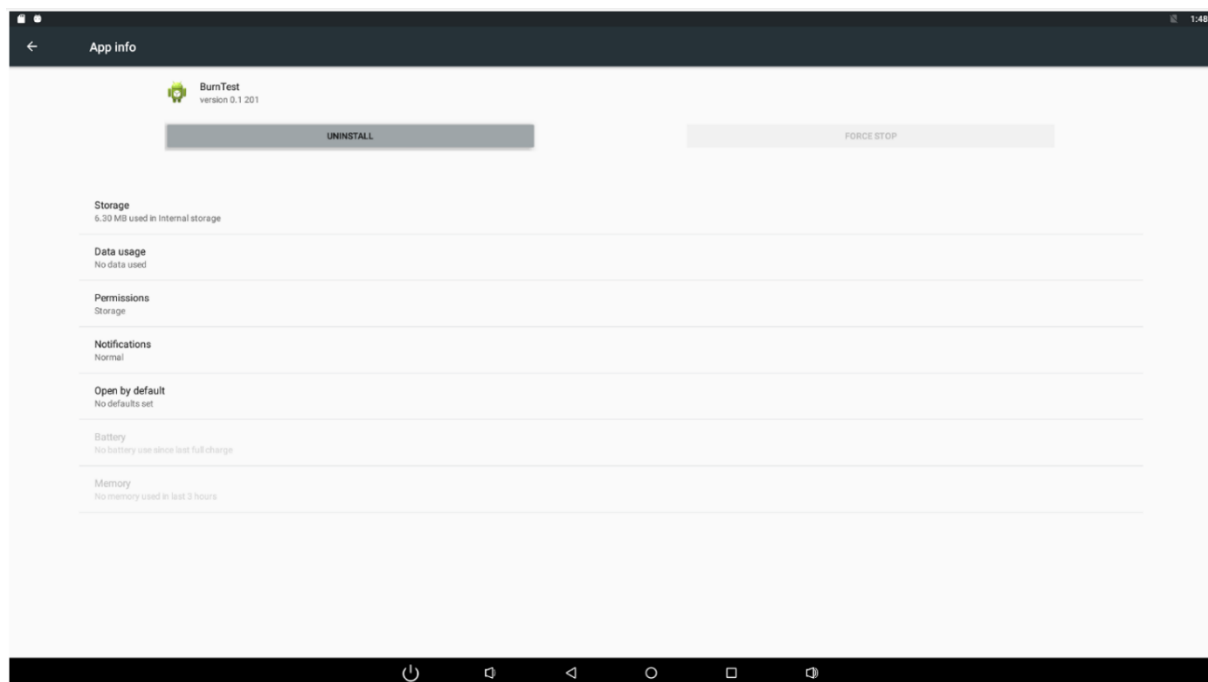

Click the “**Uninstall**” button and select “OK”, and then waiting for uninstallation finished.

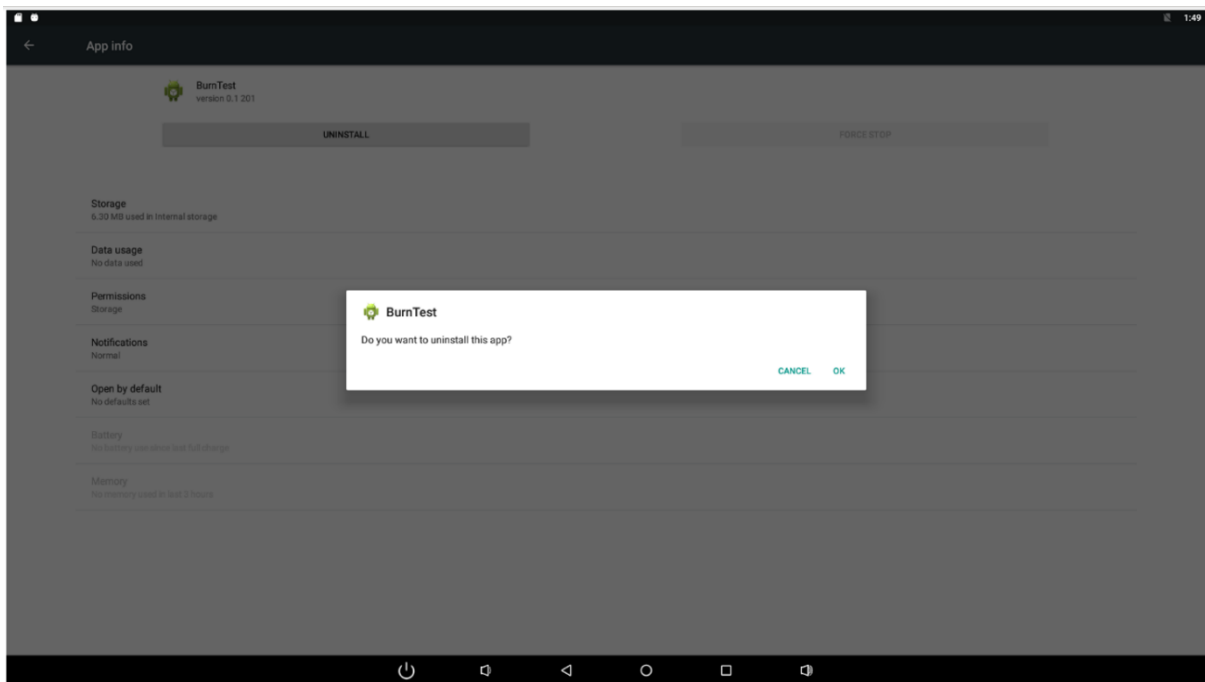

Reset to Factory Default

Please make sure to back up the important data before resetting the device.

In the App list, click “**Settings**”  to open the system setting app, and select the option “**Backup & reset**”.

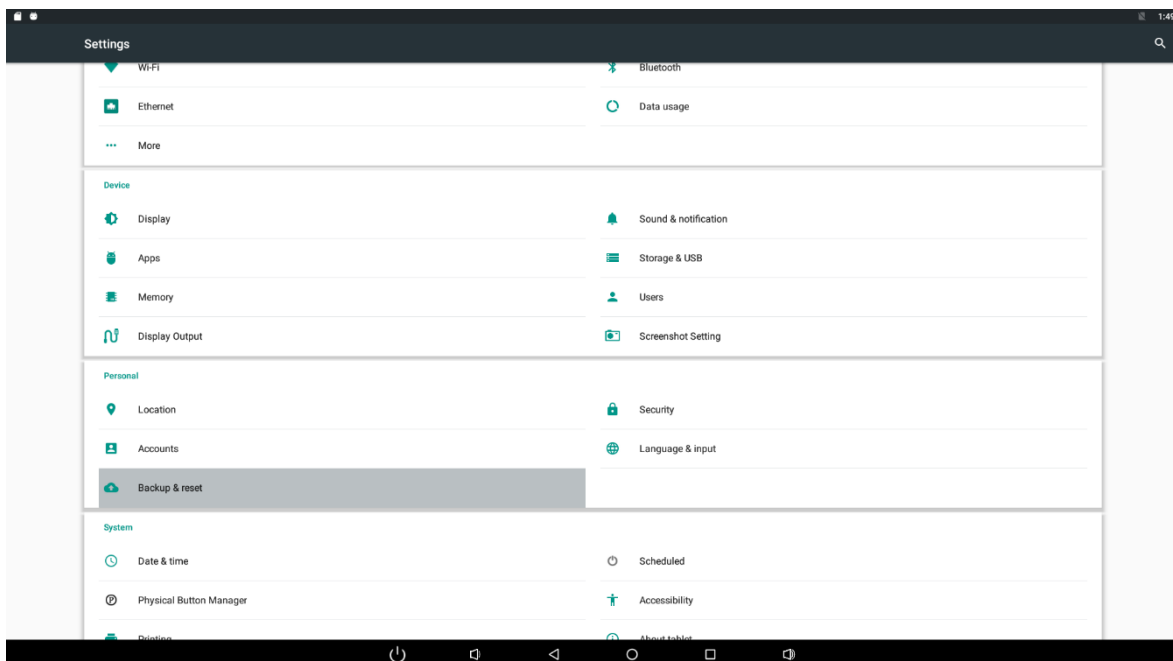

Click “Factory data reset”.

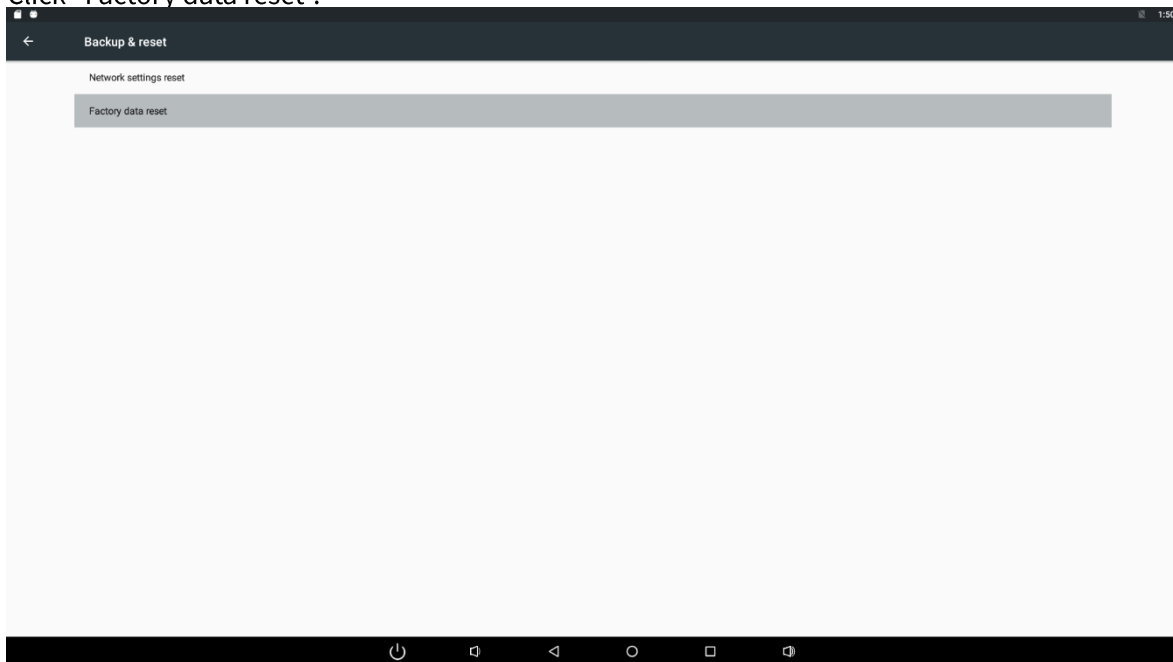

Click “Reset tablet” button.

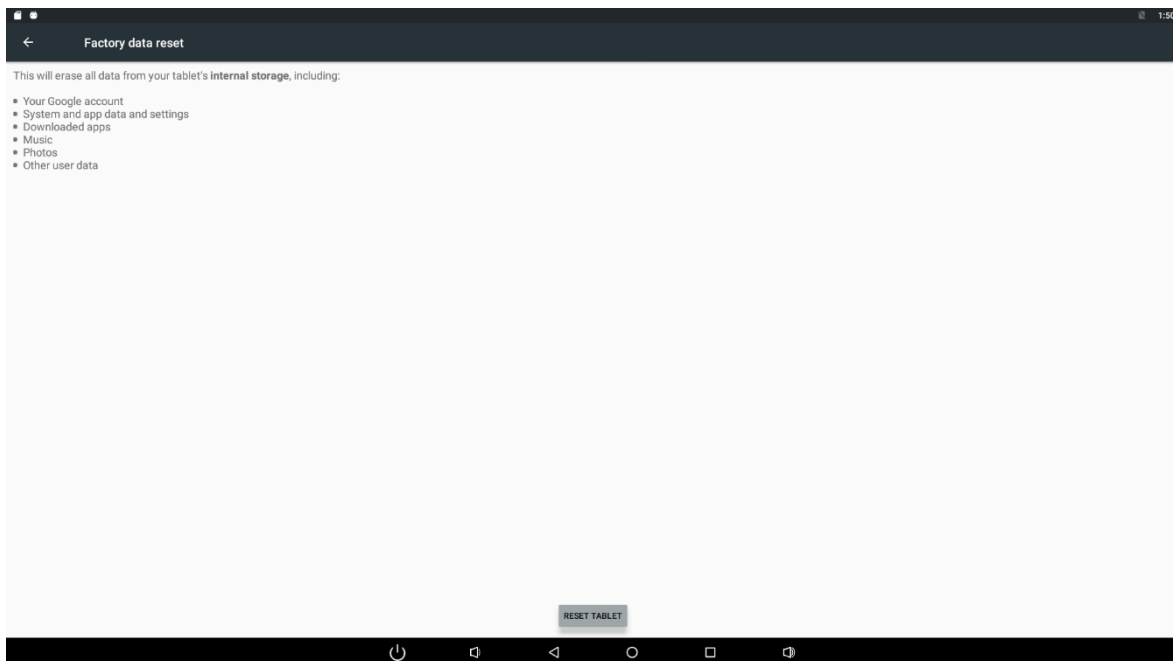

Click “Erase everything” button, and then waiting system reboots and resets to factory default.